

KENWOOD

HF/50MHz TRANSCEIVER

TS-590SG

INSTRUCTION MANUAL

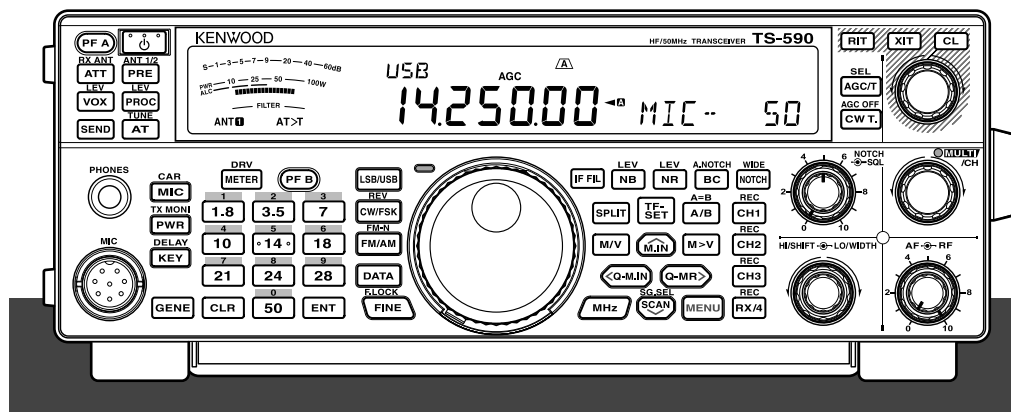

JVCKENWOOD Corporation

© B5A-0180-00 (K, E)

COPYRIGHTS FOR THIS MANUAL

JVC KENWOOD Corporation shall own all copyrights and other intellectual properties for the product and the software and for all manuals and documents attached to the product and the software.

A user is required to obtain approval from JVC KENWOOD corporation, in writing, prior to redistributing this document on a personal web page or via packet communication.

A user is prohibited from assigning, renting, leasing or reselling the document.



JVC KENWOOD Corporation does not warrant that quality and functions described in this manual comply with each user's purpose of use and, unless specifically described in this manual, JVC KENWOOD Corporation shall be free from any responsibility for any defects and indemnities for any damages or losses.

INDEMNITY

- JVC KENWOOD Corporation takes all appropriate measures to ensure all descriptions in this manual are accurate; however, this manual may still contain typographical errors ("typos") and expressions that are misleading. JVC KENWOOD Corporation is entirely free from any responsibilities arising from any losses or damages caused by such typos or expressions.
- JVC KENWOOD Corporation has the right to change or improve the product specifications, etc., described in this manual without prior notice. JVC KENWOOD Corporation is entirely free from any responsibilities for any losses or damages caused by such changes and improvements.
- JVC KENWOOD Corporation is entirely free from any responsibilities for any failures, damages or losses arising from, or in connection with, use of the transceiver with or connected to any external equipment.
- JVC KENWOOD Corporation does not warrant that the quality and functions described in this manual comply with your purpose of use and, unless specifically described in this manual, JVC KENWOOD Corporation shall be free from any responsibilities for any defects and indemnities for any damages or losses. Selection and installation of any external equipment shall be done at your own risk. You are fully responsible for the use and effects of external equipment.
- JVC KENWOOD Corporation shall be free from any responsibilities for any incidental losses or damages, such as missing communications or call opportunities caused by a failure or performance error of the transceiver.

Bu ürün 28300 sayılı Resmi Gazete'de yayımlanan Atık Elektrikli ve Elektronik Eşyaların Kontrolü Yönetmeliğe uygun olarak üretilmiştir.

Eski Elektrikli ve Elektronik Cihazların ve Pillerin İmhası Hakkında Bilgi (ayrı atık toplama sistemlerine sahip olan ülkelerde geçerlidir)

-  Bu sembolü (üzeri çizili çöp bidonu) içeren ürün ve piller evsel atı k çöpleri ile birlikte atılamaz. Kullanılmış elektrikli ve elektronik cihaz ve piller, bu tür maddeleri ve bunların yan ürünlerini iş lemeye elverişli bir geri kazanım tesisine gönderilmelidir. Size en yakın geri kazanım tesisinin konumunu öğrenmek üzere yerel yetkililerinize danışın. Doğru geri kazanım ve atık uzaklaştırma yöntemleri, sadece öz kaynakların korunmasına yardımcı olmakla kalmayıp ayrıca sağlığınıza ve çevreye olacak zararlı etkilerini engellemeye yardımcı olur. Uyarı: Pilin alt tarafında bulunan "Pb" işareti, bu pillin kurşun içerdiğini belirtir.
- 

THANK YOU

Thank you for choosing this **KENWOOD** TS-590SG transceiver. It has been developed by a team of engineers determined to continue the tradition of excellence and innovation in **KENWOOD** transceivers.

This transceiver features a Digital Signal Processing (DSP) unit to process IF and AF signals. By taking maximum advantage of DSP technology, the TS-590SG transceiver gives you enhanced interference reduction capabilities and improves the quality of audio. You will notice the differences when you fight QRM and QRN. As you learn how to use this transceiver, you will also find that **KENWOOD** is pursuing "user friendliness". For example, each time you change the Menu No. in Menu mode, you will see scrolling messages on the display, telling you what you are selecting.

Though user friendly, this transceiver is technically sophisticated and some features may be new to you. Consider this manual to be a personal tutorial from the designers. Allow the manual to guide you through the learning process now, then act as a reference in the coming years.

FEATURES

- All mode operation from HF to 50 MHz amateur radio band
- 500 Hz/ 2.7 kHz roofing filter
- Superior C/N response by the DDS largely decreases the noise of the undesired signal.
- IF DSP through the adoption of 32-bit floating point DSP
- Digital Noise Blanker
- PC interface via a Universal Serial Bus port (B-type)
- Drive output/ RX Antenna output
- Direct band keys
- Built-in Antenna Tuner
- Morse Code Decoder
- 100 W output power for SSB, CW, FSK, FM, and 25 W output power for AM.

Firmware Copyrights

The title to and ownership of copyrights for firmware embedded in **KENWOOD** product memories are reserved for JVC **KENWOOD** Corporation.

NOTICE TO THE USER

One or more of the following statements may be applicable for this equipment.

FCC WARNING

This equipment generates or uses radio frequency energy. Changes or modifications to this equipment may cause harmful interference unless the modifications are expressly approved in the instruction manual. The user could lose the authority to operate this equipment if an unauthorized change or modification is made.

INFORMATION TO THE DIGITAL DEVICE USER REQUIRED BY THE FCC

This equipment has been tested and found to comply with the limits for a Class B digital device, pursuant to Part 15 of the FCC Rules. These limits are designed to provide reasonable protection against harmful interference in a residential installation.

This equipment generates, uses and can generate radio frequency energy and, if not installed and used in accordance with the instructions, may cause harmful interference to radio communications. However, there is no guarantee that the interference will not occur in a particular installation. If this equipment does cause harmful interference to radio or television reception, which can be determined by turning the equipment off and on, the user is encouraged to try to correct the interference by one or more of the following measures:

- Reorient or relocate the receiving antenna.
- Increase the separation between the equipment and receiver.
- Connect the equipment to an outlet on a circuit different from that to which the receiver is connected.
- Consult the dealer for technical assistance.

This device complies with Industry Canada license exempt RSS standard(s). Operation is subject to the following two conditions : (1) this device may not cause interference, and (2) this device must accept any interference, including interference that may cause undesired operation of the device.

This product is designed for connection to an IT power distribution system.

NOTIFICATION

This equipment complies with the essential requirements of Directive 1999/5/EC.

The use of the warning symbol  means the equipment is subject to restrictions of use in certain countries.

This equipment requires a licence and is intended for use in the countries below.

AT	BE	DK	FI	FR	DE	GR	IS	IE
IT	LI	LU	NL	NO	PT	ES	SE	CH
GB	CY	CZ	EE	HU	LV	LT	MT	PL
SK	SI	BG	RO	HR				

ISO3166

Information on Disposal of Old Electrical and Electronic Equipment and Batteries (applicable for countries that have adopted separate waste collection systems)



Products and batteries with the symbol (crossed-out wheeled bin) cannot be disposed as household waste. Old electrical and electronic equipment and batteries should be recycled at a facility capable of handling these items and their waste byproducts.



Contact your local authority for details in locating a recycle facility nearest to you. Proper recycling and waste disposal will help conserve resources whilst preventing detrimental effects on our health and the environment.

BEFORE STARTING

Amateur radio regulations vary from country to country. Confirm your local amateur radio regulations and requirements before operating the transceiver.

Depending on the size and type of vehicle, the maximum transmission output power for the mobile operation will vary. The maximum transmission output power is usually specified by the car manufacturer to avoid interference with other electric devices used in the vehicle. Consult your car manufacturer and amateur radio equipment dealer for the requirements and installation.

MARKET CODES

K-type: The Americas

E-type: Europe

The market code is shown on the carton box.

Refer to the specifications {page 86} for information on the available operating frequencies.

WRITING CONVENTIONS FOLLOWED

The writing conventions described below have been followed to simplify instructions and avoid unnecessary repetition.

Instruction	Action
Press [KEY].	Press and release KEY.
Press Mic [KEY].	Press and release KEY on the microphone.
Press and hold [KEY].	Press and hold KEY down for a moment, then release KEY.
Hold [KEY].	Press and hold KEY down until instructed to release KEY.
Press [KEY] + [⏻].	With the transceiver power OFF, press and hold KEY, then switch the transceiver power ON by pressing [⏻].

SUPPLIED ACCESSORIES

After carefully unpacking the transceiver, identify the items listed in the table below. We recommend you keep the box and packing materials in case you need to repack the transceiver in the future.

Accessory	Comment	Quantity	
		K-type	E-type
Microphone		1	1
DC power cable		1	1
Fuse	25 A; for DC power cable	1	1
Fuse	4 A; for an external antenna tuner	1	1
DIN plug	7-pin (For REMOTE connector)	1	1
DIN plug	13-pin (For ACC2 connector)	1	1
Screw set	For bracket	1	1
Plastic spacer	For bracket	4	4
Instruction Manual	English	1	1
	French	1	1
	Spanish	–	1
	Italian	–	1
	German	–	1
Schematic diagram		2	–
Warranty Card		1	1

PRECAUTIONS

Please observe the following precautions to prevent fire, personal injury, and transceiver damage:

- Connect the transceiver only to a power source as described in this manual or as marked on the transceiver itself.
- Route all power cables safely. Ensure the power cables can neither be stepped upon nor pinched by items placed near or against the cables. Pay particular attention to locations near AC receptacles, AC outlet strips, and points of entry to the transceiver.
- Take care not to drop objects or spill liquid into the transceiver through enclosure openings. Metal objects, such as hairpins or needles, inserted into the transceiver may contact voltages resulting in serious electrical shocks. Never permit children to insert any objects into the transceiver.
- Do not attempt to defeat methods used for grounding and electrical polarization in the transceiver, particularly involving the power input cable.
- Adequately ground all outdoor antennas for this transceiver using approved methods. Grounding helps protect against voltage surges caused by lightning. It also reduces the chance of a build-up of static charge.

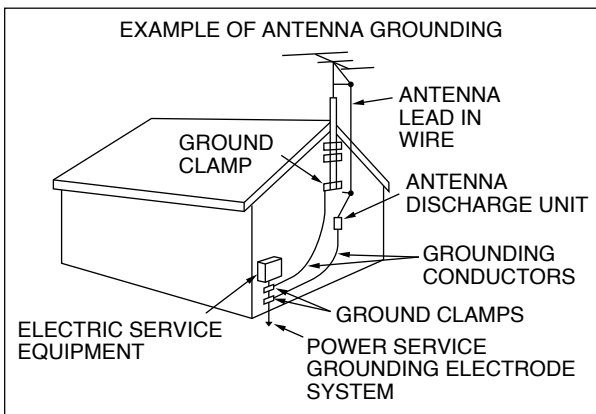

- Minimum recommended distance for an outdoor antenna from power lines is one and one-half times the vertical height of the associated antenna support structure. This distance allows adequate clearance from the power lines if the support structure fails for any reason.
- Locate the transceiver so as not to interfere with its ventilation. Do not place books or other equipment on the transceiver that may impede the free movement of air. Allow a minimum of 10 cm (4 inches) between the rear of the transceiver and the wall or operating desk shelf.
- Do not use the transceiver near water or sources of moisture. For example, avoid use near a bathtub, sink, swimming pool, or in a damp basement or attic.
- The presence of an unusual odor or smoke is often a sign of trouble. Immediately turn the power OFF and remove the power cable. Contact a **KENWOOD** service station or your dealer for advice.

- Locate the transceiver away from heat sources such as a radiator, stove, amplifier or other devices that produce substantial amounts of heat.
- Do not use volatile solvents such as alcohol, paint thinner, gasoline, or benzene to clean the cabinet of the transceiver. Use only a clean cloth with warm water or a mild detergent.
- Disconnect the input power cable from the power source when the transceiver is not used for long periods of time.
- Remove the transceiver's enclosure only to do accessory installations described in this manual or accessory manuals. Follow provided instructions carefully, to avoid electrical shocks. If unfamiliar with this type of work, seek assistance from an experienced individual, or have a professional technician do the task.
- Enlist the services of qualified personnel in the following cases:
 - a) The power supply or plug is damaged.
 - b) Objects have fallen into or liquid has spilled into the transceiver.
 - c) The transceiver has been exposed to rain.
 - d) The transceiver is operating abnormally or performance has seriously degraded.
 - e) The transceiver has been dropped or the enclosure damaged.
- Do not attempt to perform any kind of configuration or menu setup while driving.
- Do not wear headphones while driving.
- Install the transceiver in a safe and convenient position inside your vehicle so as not to subject yourself to danger while driving. Consult your car dealer for the transceiver installation to ensure safety.
- HF/ 50 MHz mobile antennas are larger and heavier than VHF/ UHF antennas. Therefore, use a strong and rigid mount to safely and securely install the HF/ 50 MHz mobile antenna.
- Do not put the plastic bag used for packing of this equipment on the place which reaches a small child's hand. It will become a cause of suffocation if it wears flatly.

CONTENTS

THANK YOU	i
FEATURES	i
NOTICE TO THE USER	i
BEFORE STARTING	ii
MARKET CODES	ii
WRITING CONVENTIONS FOLLOWED	ii
SUPPLIED ACCESSORIES	ii
PRECAUTIONS	iii
CONTENTS	iv

CHAPTER 1 INSTALLATION

ANTENNA CONNECTION	1
GROUND CONNECTION	1
LIGHTNING PROTECTION	1
DC POWER SUPPLY CONNECTION	1
UTILIZING THE BAIL	2
REPLACING FUSES	2
ACCESSORY CONNECTIONS	2
FRONT PANEL	2
Headphones (PHONES)	2
Microphone (MIC)	2
REAR PANEL	2
External Speaker (EXT.SP)	2
Keys for CW (PADDLE and KEY)	2

CHAPTER 2 GETTING ACQUAINTED

FRONT PANEL	4
LCD DISPLAY	7
REAR PANEL	9
MICROPHONE	9

CHAPTER 3 OPERATING BASICS

SWITCHING POWER ON/ OFF	10
ADJUSTING THE VOLUME	10
AF (AUDIO FREQUENCY) GAIN	10
RF (RADIO FREQUENCY) GAIN	10
SELECTING VFO A OR VFO B	10
SELECTING A BAND	11
SELECTING A MODE	11
ADJUSTING THE SQUELCH	12
TUNING A FREQUENCY	12
MULTI-FUNCTION METER	12
TRANSMITTING	13
SELECTING TRANSMISSION POWER	13
MICROPHONE GAIN	13

CHAPTER 4 MENU SETUP

WHAT IS A MENU?	14
MENU A/ MENU B	14
MENU ACCESS	14
QUICK MENU	14
PROGRAMMING THE QUICK MENU	14
USING THE QUICK MENU	14
MENU CONFIGURATION	15

CHAPTER 5 BASIC COMMUNICATIONS

SSB TRANSMISSION	21
AM TRANSMISSION	21
FM TRANSMISSION	22
NARROW BANDWIDTH FOR FM	22
CW TRANSMISSION	22
AUTO ZERO-BEAT	23
TX SIDETONE/ RX PITCH FREQUENCY	23

CARRIER LEVEL	23
---------------------	----

CHAPTER 6 ENHANCED COMMUNICATIONS

SPLIT-FREQUENCY OPERATION	24
DIRECTLY ENTERING THE FREQUENCY SPLIT SPECIFIED BY A DXer	24
TURN THE TUNING CONTROL TO SEARCH FOR THE TRANSMIT FREQUENCY	24
TF-SET (TRANSMISSION FREQUENCY SET)	24
SHIFTABLE RX FREQUENCY DURING SPLIT TRANSMISSION	25
FM REPEATER OPERATION	25
TRANSMITTING A TONE	26
Activating the Tone Function	26
Selecting a Tone Frequency	26
TONE FREQUENCY ID SCAN	26
FM CTCSS OPERATION	27
CTCSS FREQUENCY ID SCAN	27
CROSS TONE	28

CHAPTER 7 COMMUNICATING AIDS

RECEPTION	29
SELECTING YOUR FREQUENCY	29
Direct Frequency Entry	29
Frequency Entry History	29
Using the MHz key	29
Quick QSX	29
Fine Tuning	30
Tuning Control Adjustment Rate	30
Equalizing VFO Frequencies (A=B)	30
RIT (RECEIVE INCREMENTAL TUNING)	30
AGC (AUTOMATIC GAIN CONTROL)	30
AGC Time Constant Adjustment	30
TRANSMISSION	31
VOX (VOICE-OPERATED TRANSMISSION)	31
Microphone Input Level	31
Delay Time	31
Anti-VOX Adjustment	31
Data VOX	31
Data VOX Delay Time	32
USB/ ACC2 VOX Gain	32
SPEECH PROCESSOR	32
Speech Processor Effect	32
XIT (TRANSMIT INCREMENTAL TUNING)	32
CUSTOMIZING TRANSMISSION SIGNAL CHARACTERISTICS	33
TX Filter Bandwidth (SSB/ AM)	33
TX Filter Bandwidth (SSB-DATA)	33
TX Equalizer (SSB/ SSB-DATA / FM/ FM-DATA/ AM/ AM-DATA)	33
TRANSMIT INHIBIT	33
BUSY LOCKOUT	33
CHANGING FREQUENCY WHILE TRANSMITTING	33
CW BREAK-IN	34
USING SEMI BREAK-IN OR FULL BREAK-IN	34
ELECTRONIC KEYS	34
ELECTRONIC KEYS MODE	34
CHANGING KEYING SPEED	34
Invalid Break-In Operation	34
RISE TIME OF CW	35
AUTO WEIGHTING	35
Reverse Keying Weight Ratio	35
BUG KEY FUNCTION	35

CW MESSAGE MEMORY	35
Storing CW Messages	35
Checking CW Messages without Transmitting	36
Transmitting CW Messages	36
Erasing a CW Message	36
Changing the Inter-message Interval Time	36
Changing the CW Sidetone Volume	36
Insert Keying	36
FREQUENCY CORRECTION FOR CW	37
AUTO CW TX IN SSB MODE	37
MIC UP/ DWN KEY PADDLE MODE	37
SWAP DOT AND DASH PADDLE POSITIONS	37
MORSE CODE DECODER	38
THRESHOLD LEVEL ADJUSTMENT	38

CHAPTER 8 DATA COMMUNICATIONS

RADIO TELETYPE (RTTY)	39
PHASE-SHIFT KEYING 31 BAUD (PSK31)	39

CHAPTER 9 REJECTING INTERFERENCE

DSP FILTERS	40
CHANGING THE DSP FILTER BANDWIDTH	40
SSB/ FM/ AM Mode (High cut/Low cut)	40
CW/ FSK Mode (Width/Shift)	40
SSB Data Mode (Width/Shift)	40
IF Filter A and B	40
Filter control in SSB/ SSB-DATA mode (High/Low and Width/Shift)	41
AUTO NOTCH FILTER (SSB)	41
Auto Notch Tracking Speed	41
MANUAL NOTCH FILTER (SSB/ CW/ FSK)	41
Notch Filter Bandwidth	41
BEAT CANCEL (SSB/ AM)	41
NOISE REDUCTION (ALL MODES)	41
Setting the NR1 Level Adjustment	42
Setting the NR2 Time Constant	42
NOISE BLANKER	42
PRE-AMPLIFIER	42
ATTENUATOR	42
CW REVERSE (RECEPTION)	42

CHAPTER 10 MEMORY FEATURES

MEMORY CHANNELS	43
STORING DATA IN MEMORY	43
Simplex Channels	43
Split-Frequency Channels	43
MEMORY RECALL AND SCROLL	44
Memory Recall	44
Memory Scroll	44
Temporary Frequency Changes	44
MEMORY TRANSFER	44
Memory ➔ VFO Transfer	44
Channel ➔ Channel Transfer	44
STORING FREQUENCY RANGES	45
Confirming Start/ End Frequencies	46
Programmable VFO	46
MEMORY CHANNEL LOCKOUT	46
ERASING MEMORY CHANNELS	46
MEMORY CHANNEL NAME	46
QUICK MEMORY	46
NUMBER OF QUICK MEMORY CHANNELS	47
STORING INTO QUICK MEMORY	47
RECALLING QUICK MEMORY CHANNELS	47

TEMPORARY FREQUENCY CHANGES	47
QUICK MEMORY ➔ VFO TRANSFER	47
ERASING QUICK MEMORY CHANNELS	47

CHAPTER 11 SCAN

NORMAL SCAN	48
VFO SCAN	48
PROGRAM SCAN	48
PROGRAM SCAN PARTIALLY SLOWED	49
SCAN HOLD	50
MEMORY SCAN	50
SCAN RESUME	50
ALL-CHANNEL SCAN	50
GROUP SCAN	51
Memory Group	51
Scan Group Select	51
Performing Group Scan	51
QUICK MEMORY SCAN	51

CHAPTER 12 OPERATOR CONVENIENCES

ANTENNAS	52
ANT 1/ ANT 2	52
RX ANT	52
DRV	52
Selecting the DRV Connector Function	52
APO (Auto Power OFF)	52
AUTOMATIC ANTENNA TUNER	52
PRESETTING	53
AUTO MODE	53
BEEP FUNCTION	54
DISPLAY	55
BRIGHTNESS	55
BACKLIGHT COLOR	55
PANEL KEY DOUBLE FUNCTION RESPONSE TIME	55
LINEAR AMPLIFIER CONTROL	55
LOCK FUNCTIONS	56
FREQUENCY LOCK FUNCTION	56
PROGRAMMABLE FUNCTION KEYS	56
TRANSCIVER FRONT PANEL	56
MICROPHONE KEYS	56
DSP RX EQUALIZER	57
EQUALIZING RECEIVING AUDIO	57
RX MONITOR	58
TIME-OUT TIMER	58
TRANSVERTER	58
FREQUENCY DISPLAY	58
TRANSMISSION OUTPUT POWER	58
TX MONITOR	58
TX POWER	58
TX TUNE	59
ADJUSTING THE TRANSMIT OUTPUT POWER FOR TX TUNE	59
QUICK DATA TRANSFER	59
SETTING UP	59
Equipment Needed	59
Connections	59
USING QUICK TRANSFER	60
Transferring Data	60
Receiving Data	60
COMPUTER CONTROL	60
SETTING UP	60
Equipment Needed	60
Connections	60

CONTENTS

COMMUNICATION PARAMETERS	60	SERVICE NOTE	79
EXTERNAL AUDIO SETTINGS	61	CLEANING	79
Selecting a Data Transmission Line	61	FIRMWARE UPDATING	79
Audio Level Settings	61	ABOUT FIRMWARE UPDATING	79
SELECTING THE AUDIO SOURCE FOR TRANSMISSION IN DATA MODE	61	VERIFYING THE FIRMWARE VERSION	79
CHANGING THE SIGNAL FOR THE COM TERMINAL	61	TROUBLESHOOTING	80
CONTROLLING THE TS-590SG FROM A PC	61	MICROPROCESSOR RESET	83
REMOTELY CONTROLLING THE TS-590SG ON THE NETWORK	61	INITIAL SETTINGS	83
OPTIONAL VGS-1 VOICE GUIDE & STORAGE UNIT	62	VFO RESET	83
RECORDING MESSAGES	62	FULL RESET	83
MESSAGE PLAYBACK	62	OPERATION NOTICES	84
Checking Messages	62	DC POWER SUPPLY	84
Sending Messages	62	INTERNAL COOLING FAN	84
Erasing a Recorded Message	63	INTERNAL BEATS	84
Changing Inter-message Interval Time	63	AGC	84
Changing Message Playback Volume	63	60 m BAND OPERATION	84
CONSTANT RECORDING	63	CHAPTER 16 OPTIONAL ACCESSORIES	
VOICE GUIDE	63	OPTIONAL ACCESSORIES	85
Voice Guide Announcement Volume	66	CHAPTER 17 SPECIFICATIONS	
Voice Guide Announcement Speed	66	SPECIFICATIONS	86
Voice Guide Announcement Language	66		
EMERGENCY CALL (K TYPE ONLY)	66		
CROSSBAND REPEATER	66		
OPERATION	66		
DX PACKETCLUSTER TUNE	67		
SKY COMMAND SYSTEM II	67		
SKY COMMAND SYSTEM II DIAGRAM	67		
PREPARATION	68		
STARTING SKY COMMAND SYSTEM II OPERATION	68		
POWER ON MESSAGE	68		
CHAPTER 13 CONNECTING PERIPHERAL EQUIPMENT			
TERMINAL DESCRIPTIONS	69		
COM CONNECTOR	69		
ACC2 CONNECTOR	69		
REMOTE CONNECTOR	70		
EXT.AT CONNECTOR (FOR AT-300)	70		
MIC CONNECTOR	70		
CONNECTING TO DATA COMMUNICATION EQUIPMENT	71		
CONNECTING TO A COMPUTER	71		
CONNECTING TO A TNC	72		
CONNECTING TO RTTY EQUIPMENT (FSK)	72		
CONNECTION TO THE LINEAR AMPLIFIER	73		
CONNECTION TO THE TL-922	73		
CONNECTING A TYPICAL LINEAR AMPLIFIER	73		
ANTENNA TUNER	74		
COMPATIBLE TRANSCEIVER	74		
DX PACKETCLUSTER TUNE	75		
CROSSBAND REPEATER	75		
CHAPTER 14 INSTALLING OPTIONS			
REMOVING THE BOTTOM CASE	76		
VGS-1 VOICE GUIDE & STORAGE UNIT	76		
SO-3 TCXO	77		
REFERENCE FREQUENCY CALIBRATION	77		
MB-430 MOBILE BRACKET	78		
PRECAUTIONS	78		
CHAPTER 15 TROUBLESHOOTING			
GENERAL INFORMATION	79		
SERVICE	79		

1 INSTALLATION

ANTENNA CONNECTION

An antenna system consists of an antenna, feed line, and ground. The transceiver can give excellent results if the antenna system and its installation are given careful attention. Use a properly adjusted 50 Ω antenna of good quality, a high-quality 50 Ω coaxial cable, and top-quality connectors. All connections must be clean and tight.

After making the connections, match the impedance of the coaxial cable and antenna so that the SWR is 1.5:1 or less. High SWR will cause the transmit output to drop and may lead to radio frequency interference with consumer products such as stereo receivers and televisions. You may even cause interference with your own transceiver. Reports that your signal is distorted could indicate that your antenna system is not efficiently radiating your transceiver's power.

Connect your primary HF/ 50 MHz antenna feed line to ANT 1 on the rear of the transceiver. If you are using two HF/ 50 MHz antennas, connect the secondary antenna to ANT 2. Refer to page 9 for the location of the antenna connectors.

The LF band is outputted only from the DRV terminal.

Note:

- ◆ Transmitting without connecting an antenna or other matched load may damage the transceiver. Always connect the antenna to the transceiver before transmitting.
- ◆ All fixed stations should be equipped with a lightning arrester to reduce the risk of fire, electric shock, and transceiver damage.
- ◆ The transceiver's protection circuit will activate when the SWR is greater than 1.5:1; however, do not rely on protection to compensate for a poorly functioning antenna system.

GROUND CONNECTION

At a minimum, a good DC ground is required to prevent such dangers as electric shock. For superior communications, a good RF ground is required against which the antenna system can operate. Both of these conditions can be met by providing a good earth ground for your station. Bury one or more ground rods or a large copper plate under the ground, then connect this to the transceiver GND terminal. Use heavy gauge wire or a copper strap, cut as short as possible, for this connection. Do not use a gas pipe, an electrical conduit, or a plastic water pipe as a ground.

LIGHTNING PROTECTION

Even in areas where lightning storms are less common, there is always a chance that a storm will occur each year. Consider carefully how to protect your equipment and home from lightning. The installation of a lightning arrester is a start, but there is more that you can do. For example, terminate your antenna system transmission lines at an entry panel that you install outside your home. Ground this entry panel to a good outside ground, then connect the appropriate feed lines between the entry panel and your transceiver. When a lightning storm occurs, disconnecting the feed lines from your transceiver will ensure additional protection.

DC POWER SUPPLY CONNECTION

In order to use this transceiver, you need a separate 13.8 V DC power supply that must be purchased separately. Do not directly connect the transceiver to an AC outlet. Use the supplied DC power cable to connect the transceiver to a regulated power supply. Do not substitute a cable with smaller gauge wires. The current capacity of the power supply must be 20.5 A peak or more.

First, connect the DC power cable to the regulated DC power supply; the red lead to the positive terminal and the black lead to the negative terminal. Next, connect the DC power cable to the transceiver's DC power connector.

- Press the connectors firmly until the locking tab clicks.

Note:

- ◆ Before connecting the DC power supply to the transceiver, be sure to switch OFF the DC power supply and transceiver.
- ◆ Do not plug the DC power supply into an AC outlet until you make all connections.

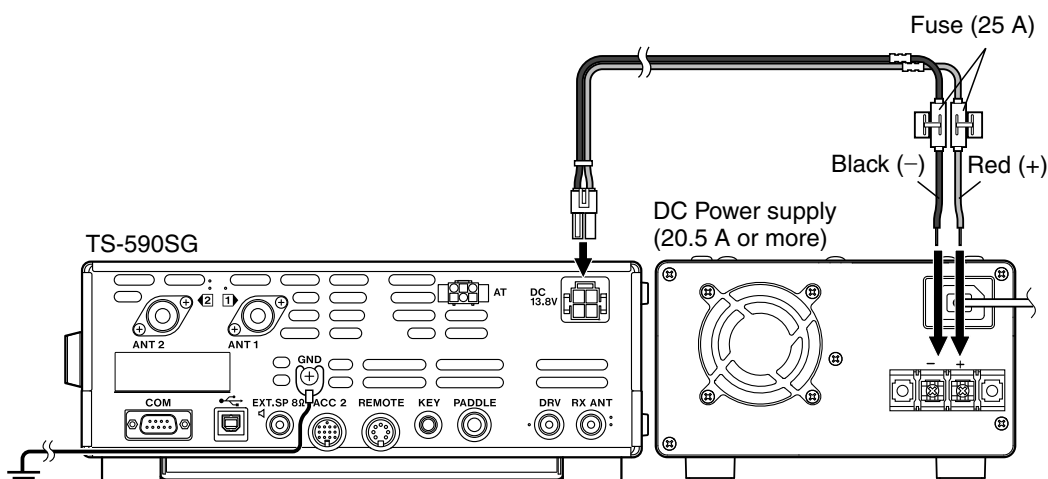

1 INSTALLATION

UTILIZING THE BAIL

This transceiver is equipped with a bail so that you can angle the transceiver. The bail is located on the bottom of the transceiver. Pull the bail forward to the limit as shown.

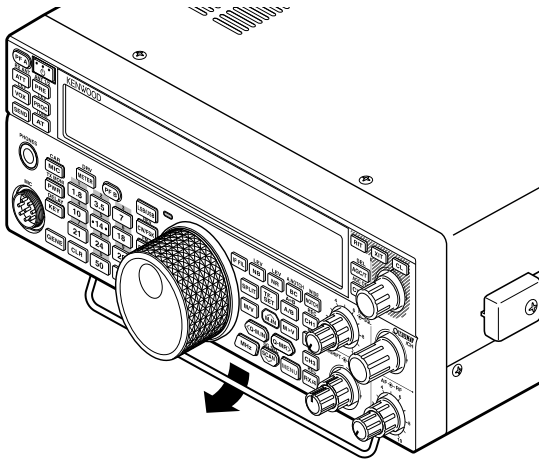

REPLACING FUSES

The following fuses are used in the TS-590SG transceiver. If a fuse blows, determine the cause then correct the problem. Only after the problem has been resolved, replace the blown fuse with a new one with the specified ratings. If newly installed fuses continue to blow, disconnect the power plug and contact a **KENWOOD** service center or your dealer for assistance.

Fuse Location	Fuse Current Rating
TS-590SG Transceiver	4 A (for external antenna tuner)
Supplied DC power cable	25 A

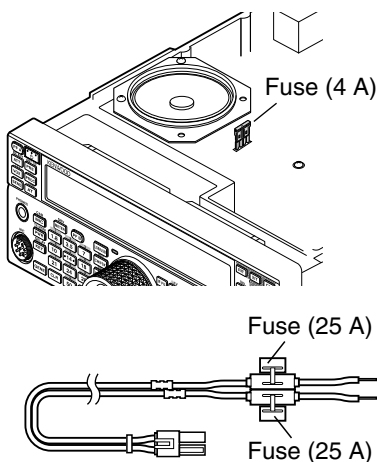

ACCESSORY CONNECTIONS

FRONT PANEL

Headphones (PHONES)

Connect monaural or stereo headphones with a 4 to 32 Ω (normal 8 Ω) impedance. This jack accepts a 6.3 mm (1/4") diameter, 2-conductor (mono) or 3-conductor (stereo) plug. After connecting the headphones, you will hear no sound from the internal (or optional external) Speaker/Microphone (MIC).

Note: Using a high impedance headphone set causes the volume to be louder.

Microphone (MIC)

Connect a microphone with a 250 to 600 Ω impedance. Fully insert the connector, then screw the retaining ring clockwise until secure. Compatible microphones include the MC-43S, MC-47, MC-52DM, MC-60A, MC-80, MC-85, and MC-90.

Note: Do not use the MC-44, MC-44DM, MC-45, MC-45E, MC-45DM, MC-45DME, or MC-53DM microphones.

REAR PANEL

External Speaker (EXT.SP)

On the rear panel of the transceiver, there is an external speaker jack. If an external speaker is connected to EXP.SP, the transceiver internal speaker will mute. Use only external speakers with an impedance of 4 to 8 Ω (8 Ω nominal). This jack accepts only 3.5 mm (1/8") diameter, 2-conductor (mono) plugs.



Do not connect headphones to this jack. The high audio output of this jack could damage your hearing.

Keys for CW (PADDLE and KEY)

For CW operation while using the internal electronic keyer, connect a keyer paddle to the PADDLE jack.

For CW operation without using the internal electronic keyer, connect a straight key, semi-automatic key (bug), electronic keyer, or the CW keyed output from a Multi mode Communications Processor (MCP) to the KEY jack.

The PADDLE and KEY jacks mate with a 6.3 mm (1/4") 3-conductor plug and a 3.5 mm (1/8") 2-conductor plug, respectively. External electronic keyers or MCPs must use positive keying to be compatible with this transceiver. Use a shielded cable between the key and the transceiver.

Note: Due to the functionality of the internal electronic keyer, you may find it unnecessary to connect both a paddle and another type of keyer unless you want to use a PC-based keyer for CW. Read the "ELECTRONIC KEYER" section {page 34} to become familiar with the internal keyer.

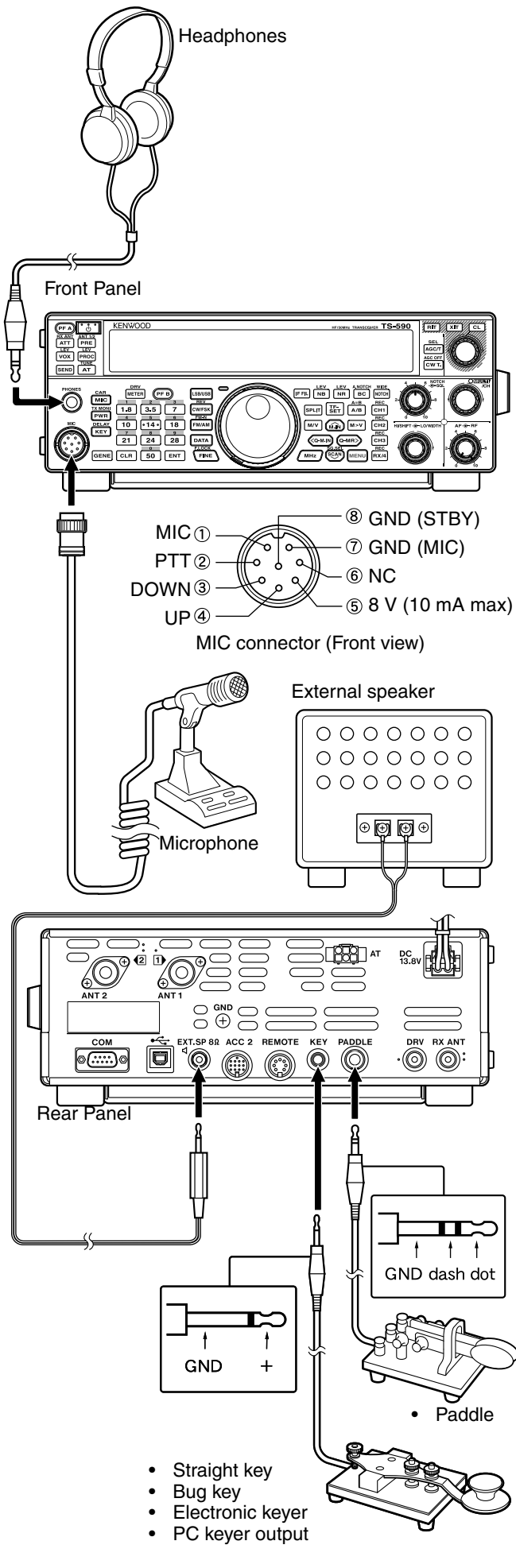

Note: Do not use a cable exceeding 3 m (9.8 feet) with the following connectors:

PHONES jack	MIC connector	COM connector
EXT. SP jack	ACC 2 connector	REMOTE connector
KEY jack	PADDLE jack	DRV connector
USB connector		

2 GETTING ACQUAINTED

FRONT PANEL

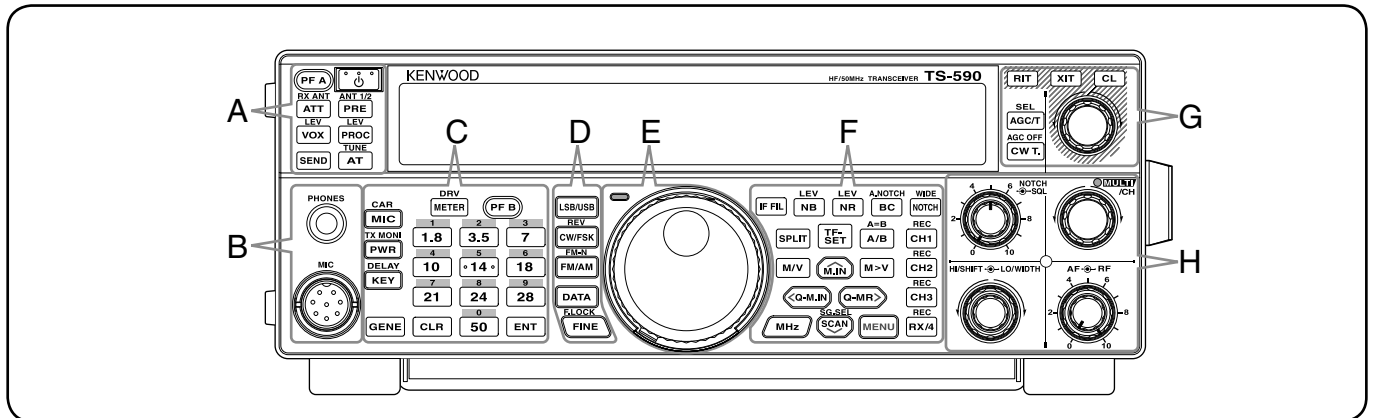

— A —

[PWR] [ON/OFF]

Press and hold to switch the transceiver power ON and OFF {page 10}.

[PF A] [PF A]

You can assign a function to this Programmable Function key {page 56}.

[ATT (RX ANT)]

Press to turn the receiver attenuator ON or OFF {page 42}. Press and hold to enable or disable the RX-ANT terminal {page 52}.

[PRE (ANT 1/2)]

Press to turn the pre-amplifier ON or OFF {page 42}. Press and hold to select either ANT 1 or ANT 2 {page 52}.

[VOX (LEV)]

In voice mode, press to turn the VOX (Voice-Operated Transmit) function ON or OFF {page 31}. In CW mode, press to turn the Break-in function ON or OFF {page 34}. Press and hold to adjust the microphone input gain for VOX operation.

[PROC (LEV)]

Press to turn the Speech Processor ON or OFF {page 32}. Press and hold to adjust the Speech Processor input level.

[SEND]

Press to turn transmission ON or OFF.

[AT (TUNE)]

Press to turn the internal antenna tuner ON or OFF {page 52}. Press and hold to start tuning the automatic antenna tuner.

— B —

PHONES jack

Mate with a 6.3 mm (1/4") diameter, 2-conductor (mono) or 3-conductor (stereo) plug for connecting a set of headphones {page 2}.

MIC connector

Connect a microphone to this connector {page 2}.

— C —

[METER (DRV)]

Press to switch the meter type {page 12}. Press and hold to select the Drive output or Antenna output {page 52}.

[PF B] [PF B]

You can assign a function to this Programmable Function key {page 56}.

[MIC (CAR)]

Press to adjust the microphone gain {page 13}. While the Speech Processor function is ON, press to adjust the Speech Processor output level {page 32}. Press and hold to adjust the carrier level {page 23}.

[PWR (TX MONI)]

Press to adjust the transmission output power {pages 13, 58}. Press and hold to turn the transmission signal monitor function ON or OFF {page 58}.

[KEY (DELAY)]

Press to adjust the internal electronic keyer speed {page 34}. Press and hold to adjust the VOX delay time for voice mode {page 31} or Break-in time (Full Break-in/ Semi Break-in time) for CW mode.

[GENE]

Press to select the general coverage band memory {page 11}.

[1.8 (1)]

Press to select the 1.8 MHz band memory {page 11} or enter keypad number 1.

[3.5 (2)]

Press to select the 3.5 MHz band memory {page 11} or enter keypad number 2.

[7 (3)]

Press to select the 7 MHz band memory {page 11} or enter keypad number 3.

[10 (4)]

Press to select the 10 MHz band memory {page 11} or enter keypad number 4.

[14 (5)]

Press to select the 14 MHz band memory {page 11} or enter keypad number 5.

[18 (6)]

Press to select the 18 MHz band memory {page 11} or enter keypad number 6.

[21] [21 (7)]

Press to select the 21 MHz band memory {page 11} or enter keypad number 7.

[24] [24 (8)]

Press to select the 24 MHz band memory {page 11} or enter keypad number 8.

[28] [28 (9)]

Press to select the 28 MHz band memory {page 11} or enter keypad number 9.

[50] [50 (0)]

Press to select the 50 MHz band memory {page 11} or enter keypad number 0.

[CLR] [CLR]

Press to exit from, abort, or reset various functions. Press and hold to clear a memory channel {page 46}.

[ENT] [ENT]

Press to enter your desired frequency using the 10-key keypad {page 29}.

— D —**[LSB/USB] [LSB/USB]**

Press to select LSB or USB mode {page 11}.

[CW/FSK (REV)] [CW/FSK (REV)]

Press to select CW or FSK mode {page 11}. Press and hold to select a sideband (CW/ CW-R or FSK/ FSK-R).

[FM/AM (FM-N)] [FM/AM (FM-N)]

Press to select FM or AM mode {page 11}. Press and hold to select Narrow FM mode.

[DATA] [DATA]

Press to select a Data mode (LSB/ LSB-DATA, USB/ USB-DATA, FM/ FM-DATA, or AM-DATA) {page 11}. In CW mode, Press to toggle the Morse Code Decoder ON and OFF. Press and hold to enter the threshold level adjustment mode for Morse Code Decoder {page 38}.

[FINE (F.LOCK)] [FINE (F.LOCK)]

Press to activate the Fine tuning function to allow more precise tuning {page 30}. Press and hold to activate the Frequency Lock function {page 56}.

— E —**Central (Tuning) control**

Turn to select the desired frequency {page 12}. Use the convenient finger-tip cavity for continuous tuning. Slide the lever underneath the **Tuning** control to the left or right to adjust the torque level of the control. Left makes the control light and right makes it heavy.

**TX-RX LED**

Lights red while transmitting and green when the squelch opens while receiving.

— F —**[IF FIL] [IF FIL]**

Press to toggle between IF Filter A and IF Filter B {page 40}. You can adjust the filter bandwidth using the **LO/WIDTH** and **HI/SHIFT** controls. Press and hold **[IF FIL]** to momentarily display each setting value of the current DSP filter DSP filter bandwidth {page 40}.

[NB (LEV)] [NB (LEV)]

Press to cycle through Noise Blanker 1, Noise Blanker 2, and OFF. Press and hold to adjust the Noise Blanker level {page 42}.

[NR (LEV)] [NR (LEV)]

Press to cycle through the DSP Noise Reduction types: NR1, NR2, or OFF {page 41}. When the Noise Reduction function is turned ON, press and hold to change the parameters of the Noise Reduction function {page 42}.

[BC (A.NOTCH)] [BC (A.NOTCH)]

Press to select the DSP Beat Cancel function, BC1 (Beat Cancel 1), BC2 (Beat Cancel 2) or OFF {page 41}. Press and hold to toggle the Auto Notch Filter ON and OFF {page 41}.

[NOTCH (WIDE)] [NOTCH (WIDE)]

Press to toggle the IF Notch Filter ON or OFF {page 41}. Press and hold to set up the IF Notch bandwidth {page 41}.

[SPLIT] [SPLIT]

Press to enter split-frequency operation, allowing you to use different transmission and reception frequencies {page 24}. Press and hold to enter the Split RX frequency setup mode.

[TF-SET] [TF-SET]

During split-frequency operation, press to monitor or change your transmit frequency {page 24}.

[A/B (A=B)] [A/B (A=B)]

Press to select either VFO A or VFO B {page 10}. Press and hold to duplicate the data in the current VFO to the other VFO {page 25}. While in Menu mode, press to select Menu A or Menu B. While in Program Memory Channel mode, press to recall the start or end frequency.

[M/V] [M/V]

Press to toggle between Memory and VFO modes.

[M.IN] [M.IN]

Press to enter Memory Scroll mode and to store data to a Memory channel {page 43}.

[M>V] [M>V]

Press to transfer the current Memory Channel contents to the VFO.

[Q-M.IN] [Q-M.IN]

Press to store data to the Quick Memory {page 46}.

[Q-MR] [Q-MR]

Press to recall data from the Quick Memory {page 47}, while in VFO mode. Press to enter Memory Name Edit mode, while in Memory Channel mode {page 46}.

[MHz] [MHz]

Press to turn the MHz Up/ Down function ON or OFF. The MHz digit increases or decreases when you turn the **MULTI/CH** control. In Menu mode, press to turn the Quick Menu ON or OFF {page 14}.

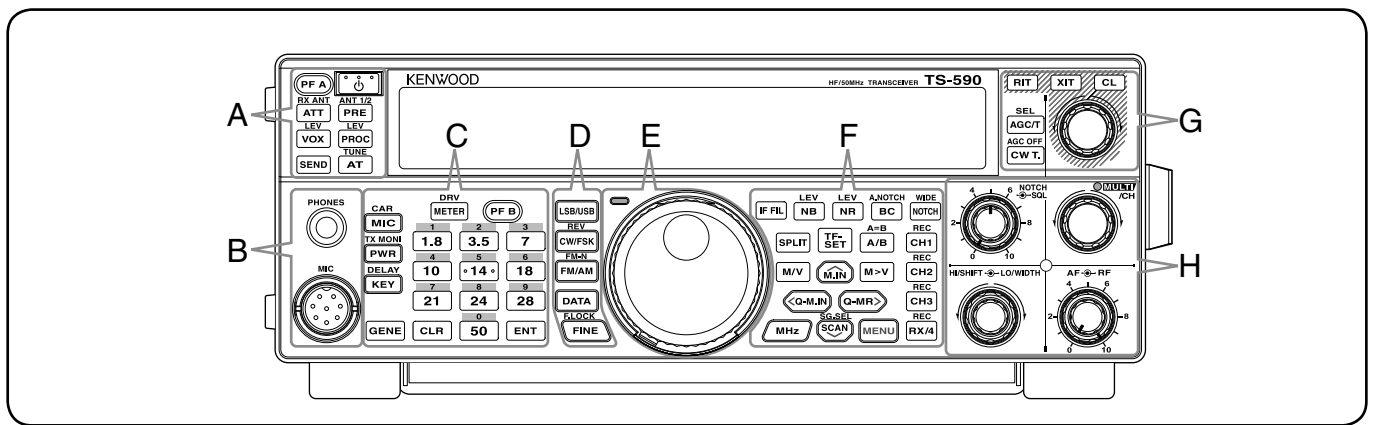

[SCAN (SG.SEL)]

Press to start or stop the Scan function {page 48}. Press and hold to select a Scan group {page 51}.

[MENU]

Press to enter Menu mode {page 14}.

[CH1 (REC)]

Press to play back a CW {page 36} or voice message (requires VGS-1 option) {page 62}. Press and hold to record a CW {page 35} or voice message (requires VGS-1 option) {page 62}.

[CH2 (REC)]

Press to play back a CW {page 36} or voice message (requires VGS-1 option) {page 62}. Press and hold to record a CW {page 35} or voice message (requires VGS-1 option) {page 62}.

[CH3 (REC)]

Press to play back a CW {page 36} or voice message (requires VGS-1 option) {page 62}. Press and hold to record a CW {page 35} or voice message (requires VGS-1 option) {page 62}.

[RX/4 (REC)]

Press to play back a CW {page 36} or voice message (requires VGS-1 option) {page 62}, or the constantly recorded signal (requires VGS-1 option) {page 63}. Press and hold to activate the constant recorder (requires VGS-1 option) {page 63}.

— G —

[AGC/T (SEL)]

Press to toggle the fast or slow response time for the Automatic Gain Control (AGC) {page 30}. In FM mode, press to cycle through the Tone settings: Tone, CTCSS, CTCSSx, or OFF {page 26}. When Tone is activated in FM mode, press and hold to select a Tone frequency {page 26}. When CTCSS is activated in FM mode, press and hold to select a CTCSS frequency {page 27}.

[CW T. (AGC OFF)]

Press to start CW auto tuning {page 23}. Press and hold to turn AGC OFF {page 30}.

[RIT]

Press to turn the RIT (Receive Incremental Tuning) function ON or OFF {page 30}.

You can assign a function to this Programmable Function key {page 56}.

[XIT]

Press to turn the XIT (Transmit Incremental Tuning) function ON or OFF {page 32}.

You can assign a function to this Programmable Function key {page 56}.

[CL]

Press to clear the RIT/ XIT frequency to zero {pages 30, 32}.

You can assign a function to this Programmable Function key {page 56}.

RIT/ XIT control

When the RIT/ XIT function is ON, turn to adjust the offset frequency. The RIT/ XIT offset frequency appears on the sub-display {pages 30, 32}. While scanning, turn to adjust the scan speed.

— H —

SQL control

Turn to select the desired squelch level {page 12}.

NOTCH control

Turn to select the desired Notch frequency {page 41}.

MULTI/CH control

In VFO mode, rotate to step the operating frequency up or down {page 29}. In Memory Channel mode, rotate to select a Memory Channel {page 43}. Also, used for selecting Menu numbers when accessing the Menu mode {page 14} and for various configurations. The MULTI/CH LED lights when the MULTI/CH control is not being used to adjust the step frequency.

You can assign a function to this Programmable Function key {page 56}.

HI/SHIFT control

Rotate to adjust the DSP filter bandwidth (high-cut) or to adjust the DSP filter bandwidth (filter band shift) {page 40}.

LOWWIDTH control

Rotate to adjust the DSP filter bandwidth (high-cut or shift) {page 40}.

AF control

Turn to adjust the AF gain level {page 10}.

RF control

Turn to adjust the RF gain level {page 10}.

LCD DISPLAY

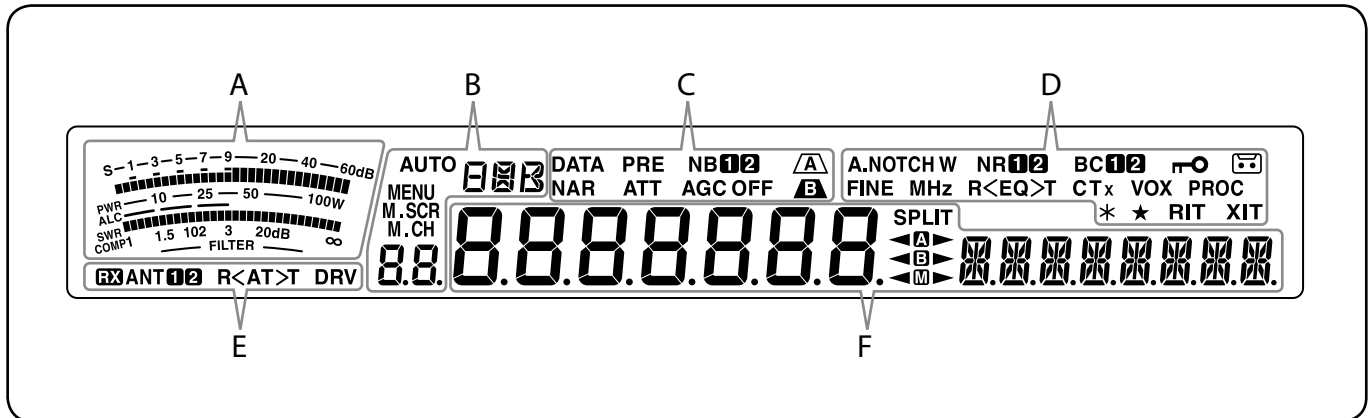

— A —

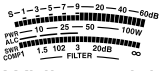

While receiving, the meter serves as an S-meter to measure and display the received signal strength. While transmitting, it serves as a power meter plus an ALC meter, an SWR meter, or a Speech Processor compression meter. While adjusting the IF filter bandwidth, the meter displays an adjustment state {page 12}.

— B —

AUTO

Appears when the Auto Mode function is ON and while in Auto Mode frequency setup {page 53}.

QRB

Displays the operating mode (USB, LSB, FM, AM, CW, CWR, FSK, or FSR) {page 11}.

MENU

Appears while in Menu mode {page 14}.

M.SCR

Appears while in Memory Scroll mode {page 44}.

M.CH

Appears while in Memory Channel mode or Memory Scroll mode {page 44}.

8.8

In normal operating mode and various configuration modes, it displays the Memory Channel number, Quick Memory number, and entry log number. In Menu mode, it displays the Menu No.

— C —

DATA

Appears while in Data mode {page 11} and while in Morse Code Decoder mode {page 38}.

NAR

Appears while in narrow FM mode {page 11}.

PRE

Appears when the receiver pre-amplifier is ON {page 42}.

ATT

Appears when the receiver's attenuator is ON {page 42}.

NB12

Appears when the Noise Blanker 1 or 2 is ON {page 42}.

AGC OFF

“AGC -F” (fast) or “AGC” (slow) appears when the Automatic Gain Control function is ON. “AGC OFF” appears when the AGC is OFF {page 30}.

A

Appears when IF filter A is selected {page 40}.

B

Appears when IF filter B is selected {page 40}.

— D —

A.NOTCH W

“NOTCH” appears when manual notch is set to Normal. “NOTCH W” appears when Manual Notch is set to Wide. “A.NOTCH” appears when Auto Notch is selected {page 41}.

FINE

Appears when the Fine Tuning function is ON {page 30}.

MHz

Appears when the MHz Step function is ON {page 29}. Also appears when the Quick Menu function is ON {page 14}.

NR12

“NR1” or “NR 2” appears, depending on whether DSP Noise Reduction 1 or Noise Reduction 2 is selected {page 41}.

R<EQ>T

“R<EQ” appears when the RX Equalizer function is ON {page 57}. “EQ>T” appears when the TX Equalizer function is ON {page 33}.

BC12

“BC1” or “BC 2” appears, when you select the DSP Beat Cancel 1 or Beat Cancel 2 {page 41}.

CTx

“T” appears when the Tone function is ON {page 26}, and blinks during Tone scan. “CT” appears when the CTCSS (Continuous Tone Coded Squelch System) function is ON, and blinks during CTCSS scan {page 27}. “CTx” appears when the Cross Tone function is ON {page 28}.

2 GETTING ACQUAINTED

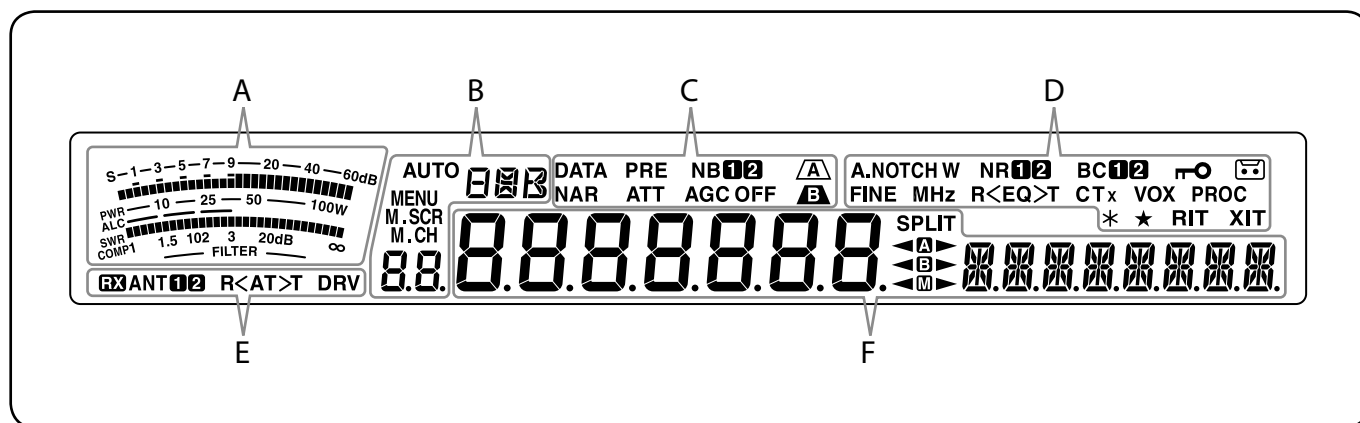

VOX

Appears when the VOX (Voice Operated Transmission) function is ON or the Break-in function is ON for CW mode {page 31}.



Appears when the Frequency Lock function is ON {page 56}.

PROC

Appears when the Speech Processor function is ON {page 32}.



Appears when the constant recording function is ON {page 63}.

*

Appears when the Antenna output is enabled (DRV connector) {page 52}.

★

Appears when the selected Menu No. is in the Quick Menu list {page 14}. It also appears when the transceiver is scanning the frequencies between the slow down frequency points {page 49}.

RIT

Appears when Receive Incremental Tuning function is ON {page 30}.

XIT

Appears when Transmit Incremental Tuning function is ON {page 32}.

— E —



Appears when the RX ANT terminal is enabled {page 52}.

ANT 1 2

Either “ANT 1” or “ANT 2” appears, depending on which antenna connector is selected {page 52}.

R<AT>

“>T” appears while the internal antenna tuner {page 52} is in-line for operation. “R<” appears while receiving when the internal antenna tuner is in-line for operation. “R<” and “>T” blink while tuning is in progress {page 52}.

DRV

Appears when the Drive output is enabled (DRV connector) {page 52}.

— F —

8.8.8.8.8.8.8.8

(Main Display)

In normal operating mode and various configuration modes, it displays the transceiver operating frequency. In Menu mode, it displays the various menus, and in Adjustment mode, it displays the adjustment values.

8.8.8.8.8.8.8.8

(Sub-display)

When recalling a memory channel, it displays the Memory Channel name (if one has been programmed). During split frequency operation, it displays the frequency. When the following indications occur simultaneously, information is displayed in the following order: RIT/XIT frequency, Split frequency, Memory Name. In Menu mode, it displays a menu title. In other modes, it displays the configuration parameters. When the Morse Code Detector function is ON, the decoded characters will be displayed.

SPLIT

Appears when the split-frequency operation is ON {page 24}.



“<A>” appears while VFO A is selected. “>A” appears while transmitting on a split channel in VFO A {page 10}. “A” appears while Menu A is being accessed in Menu mode {page 14}.



“” appears while VFO B is selected. “>B” appears while transmitting on a split channel in VFO B {page 10}. “B” appears while Menu B is being accessed in Menu mode {page 14}.



“<M>” appears while a simplex memory channel is selected. “<M>” appears while a split memory channel is selected {page 43}.

REAR PANEL

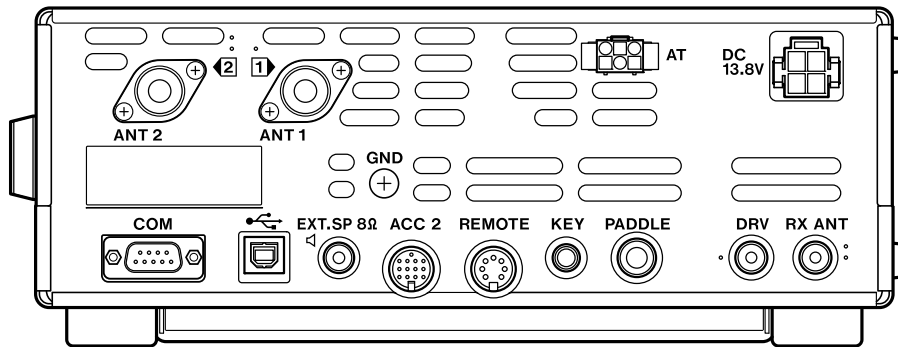

ANT 1 and ANT 2 connectors

Connect your primary HF/ 50 MHz antenna to **ANT 1** connector. If you are using 2 antennas for the HF/ 50 MHz band, connect the secondary antenna to the **ANT 2** connector {page 1}.

GND post

Connect a heavy gauge wire or copper strap between the ground post and the nearest earth ground {page 1}.

AT connector

Mates with the connector from the cable supplied with the AT-300 external antenna tuner {pages 70, 74}. Refer to the instruction manual supplied with the tuner for more information.

DC 13.8 V connector

Connect a regulated 13.8 V DC power source to this connector {page 1}. Use the DC cable supplied with the transceiver.

COM connector

Mates with a DB-9 female connector for connecting a computer or compatible transceiver {pages 60, 69}. Also used with the Quick Data Transfer function {page 59} and DX PacketCluster Tune function {page 67}.

• (USB) connector

Mates with a USB connector for connecting a computer via one of its USB ports {pages 60}.

EXT.SP 8Ω jack

Mate with a 3.5 mm (1/8"), 2-conductor (mono) plug for connecting an external speaker {page 2}.

ACC 2 connector

Mates with a 13-pin male DIN connector for connecting various accessory equipment, such as an external TNC/ MCP or a RTTY terminal {page 69}.

REMOTE connector

Mates with a 7-pin male DIN connector for connecting an HF/ 50 MHz linear amplifier {page 70, 73}.

KEY and PADDLE jacks

The **KEY** jack mates with a 3.5 mm (1/8") 2-conductor plug for connecting an external key for CW operation. The **PADDLE** jack mates with a 6.3 mm (1/4") 3-conductor plug for connecting a keyer paddle to the internal electronic keyer. Refer to "Keys for CW (PADDLE and KEY)" {page 2} before using these jacks.

DRV connector

Connect a drive device (DRO) or external receiver (ANT) to this RCA connector {page 52}.

RX ANT connector

Connect a separate receive-only antenna for HF low bands to this RCA connector {page 52}.

MICROPHONE

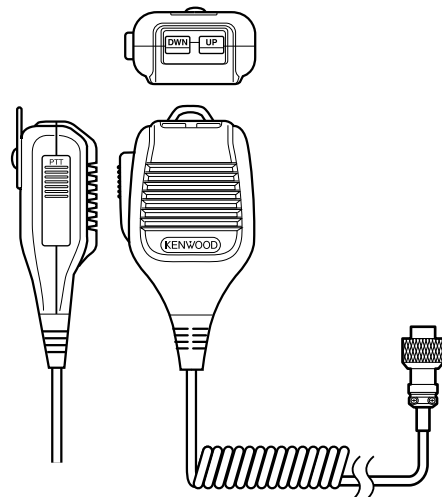

PTT (Push-to-Talk) switch

The transceiver is placed in Transmission mode when this non-locking switch is held down. Releasing the switch returns the transceiver to Reception mode.

UP / DOWN Mic [UP] / [DWN]

Use these keys to step the VFO frequency, Memory Channels, or Menu selections up and down. Press and hold these keys to continuously change the settings.

You can also change the operational function of these keys {page 56}

3 OPERATING BASICS

SWITCHING POWER ON/ OFF

- 1 Switch the DC power supply ON.
- 2 Press [⏻] to switch the transceiver ON.
 - If you hold the power switch for more than approximately 2 seconds, the transceiver will switch back OFF.
 - Upon power up, “HELLO” appears on the main display, followed by the current frequency and other indicators.

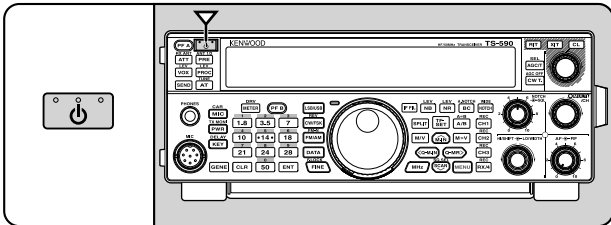

- 3 To switch the transceiver OFF, press [⏻] again.
- 4 Switch the DC power supply OFF.
 - You may skip step 3. After switching the transceiver ON, you can switch it OFF or ON using only the power switch of the DC power supply. The transceiver remembers the power switch position when the DC power source is switched OFF.

ADJUSTING THE VOLUME

AF (AUDIO FREQUENCY) GAIN

Turn the **AF** control clockwise to increase the audio level and counterclockwise to decrease it.

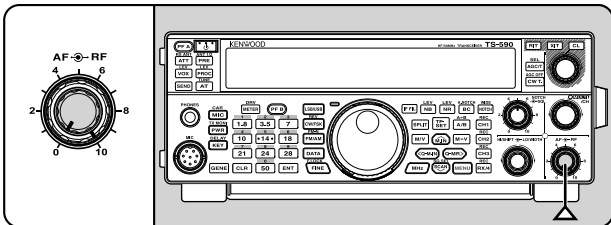

Note: The position of the **AF** control does not affect the volume of beeps caused by pressing keys nor the CW TX sidetone. The audio level for Digital mode operation is also independent of the **AF** control setting.

RF (RADIO FREQUENCY) GAIN

The RF gain is normally configured to the maximum level regardless of the operating modes. The transceiver has been configured to the maximum level at the factory. However, you may decrease the RF gain slightly when you have trouble hearing the desired signal due to excessive atmospheric noise or interference from other stations.

First, take note of the peak S-meter reading of the desired signal. Then, turn the **RF** control counterclockwise until the S-meter reads the peak value that you noted.

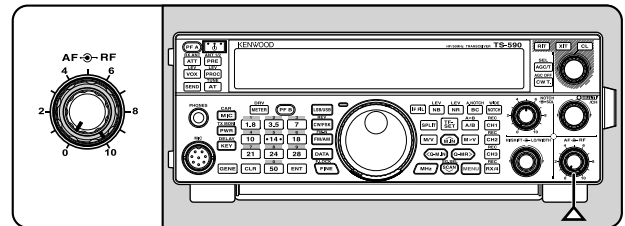

- Signals that are weaker than this level will be attenuated and reception of the station will become easier.

Depending on the type and gain of your antenna and the condition of the band, adjust the RF gain. When using FM mode, always adjust the RF gain to the maximum level.

SELECTING VFO A OR VFO B

Two VFOs are available for controlling the frequency on the transceiver. Each VFO (VFO A and VFO B) works independently so that a different frequency and mode can be selected. For example, when SPLIT operation is activated, VFO A is used for reception and VFO B is used for transmission. The opposite combination is also possible.

Press [A/B (A=B)] to toggle between VFO A and B.

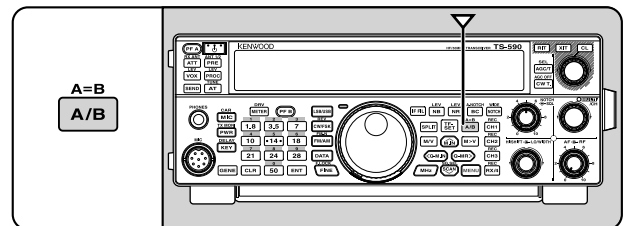

SELECTING A BAND

Press [1.8 (1)] ~ [50 (0)] or [GENE] to select your desired band.

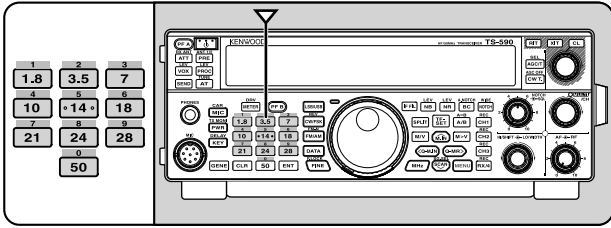

- Press each key to cycle through the 3 default settings as shown in the table below.
- Each setting can be modified with your personal preference for frequency and mode. After modifying the setting, pressing the key again will save that setting.

Key	Type	Frequency Range (MHz)	Default Setting (MHz)/ Mode		
			1	2	3
[1.8 (1)]	K	1.62 ~ 2	1.8/ CW	1.82/ CW	1.84/ CW
	E		1.83/ CW	1.84/ CW	1.81/ CW
[3.5 (2)]	K	3 ~ 4	3.5/ LSB	3.7/ LSB	3.8/ LSB
	E				3.79/ LSB
[7 (3)]	K	6.5 ~ 7.5	7.0/ LSB	7.1/ LSB	7.2/ LSB
	E			7.05/ LSB	7.1/ LSB
[10 (4)]	All	10 ~ 10.5	10.1/ CW	10.12/ CW	10.14/ CW
[14 (5)]	All	13.5 ~ 14.5	14.0/ USB	14.1/ USB	14.2/ USB
[18 (6)]	All	18 ~ 19	18.068/ USB	18.11/ USB	18.15/ USB
[21 (7)]	All	20.5 ~ 21.5	21.0/ USB	21.15/ USB	21.3/ USB
[24 (8)]	All	24 ~ 25	24.89/ USB	24.93/ USB	24.95/ USB
[28 (9)]	All	27.5 ~ 30	28/ USB	28.3/ USB	29/ FM
[50 (0)]	K	50 ~ 54	50/ USB	50.125/ USB	51/ FM
	E			50.15/ USB	
[GENE]	K	0.03 ~ 60	0.1357/ CW	0.4720/ CW	5.3305/ USB
	E				5.2585/ USB

SELECTING A MODE

Press one of the following keys to select your desired mode set: [LSB/USB], [CW/FSK (REV)], or [FM/AM (FM-N)].

[LSB/USB]

Press to select LSB or USB mode. Press again to toggle between LSB and USB mode. While in LSB mode, press [DATA] to toggle between LSB and LSB-DATA mode. Likewise, while in USB mode press [DATA] to toggle between USB and USB-DATA mode.

Additionally, while in LSB-DATA or USB-DATA mode, you can press [LSB/USB] to toggle between LSB-DATA and USB-DATA mode.

[CW/FSK (REV)]

Press to select CW or FSK mode. Press again to toggle between CW and FSK mode.

While in CW mode, press and hold [CW/FSK (REV)] to toggle between CW and CW-R mode. Likewise, while in FSK mode press and hold [CW/FSK (REV)] to toggle between FSK and FSK-R mode.

Additionally, while in CW-R or FSK-R mode, you can press [CW/FSK (REV)] to toggle between CW-R and FSK-R mode.

[FM/AM (FM-N)]

Press to select FM or AM mode. Press again to toggle between FM and AM mode.

While in FM mode, press and hold [FM/AM (FM-N)] to toggle between FM and FM-NAR mode, or press [DATA] to toggle between FM and FM-DATA mode. Additionally, while in FM-NAR mode, press [DATA] to toggle between FM-NAR and FM-NAR-DATA mode and while in FM-DATA mode, press and hold [FM/AM (FM-N)] to toggle between FM-DATA and FM-NAR-DATA mode.

While in AM mode, press [DATA] to toggle between AM and AM-DATA mode.

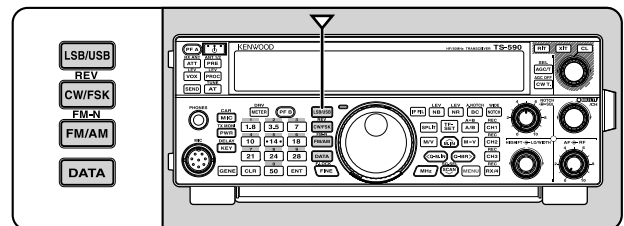

Access Menu No. 27 then press [M.IN] to select "on" to turn the Auto Mode selection ON. When it is ON, "AUTO" appears. As a default, if you change the frequency above or below 9.5 MHz, the transceiver automatically switches modes; LSB for frequencies under 9.5 MHz and USB for frequencies 9.5 MHz and over. You can further add the frequency borders to the Auto Mode selection {page 53}.

3 OPERATING BASICS

ADJUSTING THE SQUELCH

The purpose of the Squelch is to mute the speaker when no signals are present. With the squelch level correctly set, you will hear sound only while actually receiving signals. The higher the selected squelch level, the stronger the signals must be to receive. The appropriate squelch level depends on the ambient RF noise conditions.

Turn the **SQL** control when there are no signals present to select the squelch level at which the background noise is just eliminated; the green TX-RX LED will turn off. Many ham operators prefer leaving the **SQL** control fully counterclockwise unless operating on a full-carrier mode such as FM. The squelch level for the transceiver is preset at the factory to approximately the 9 o'clock position for FM and 11 o'clock for SSB and AM.

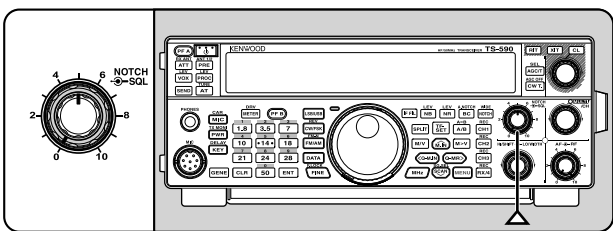

TUNING A FREQUENCY

Turn the **Tuning** control clockwise or press Mic [UP] to increase the frequency. Turn the **Tuning** control counterclockwise or press Mic [DWN] to decrease the frequency.

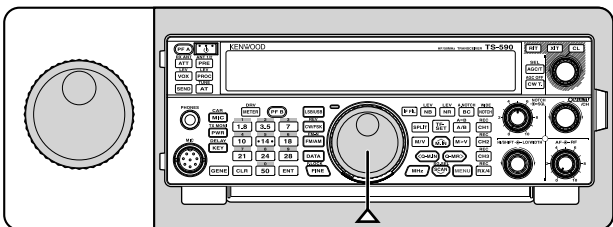

You may prefer directly entering a frequency using the numeric keypad if the desired frequency is far from the current frequency. Press [ENT], then press the numeric keys as necessary. For details, refer to "Direct Frequency Entry" {page 29}.

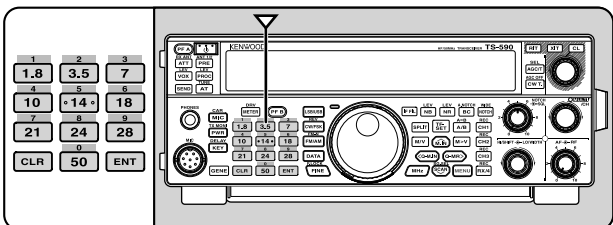

MULTI-FUNCTION METER

The multi-function meter measures the parameters in the table below. The S-meter and FILTER scales appears when the transceiver is in receive mode, and the PWR meter appears when it is in transmit mode. Each press of [METER (DRV)] cycles between the ALC, COMP, and SWR meters. Peak readings for the S-meter, ALC, SWR, COMP, and PWR functions are held momentarily.

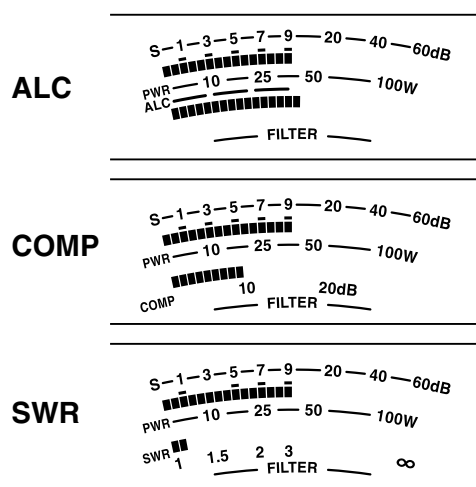
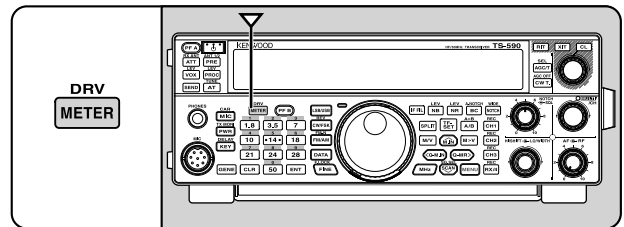

Meter Name	Parameters Measured
S	Strength of received signals
PWR	Transmission output power
ALC	Automatic level control status
SWR	Antenna system standing wave ratio
COMP	Speech compression level when using the Speech Processor {page 32}
FILTER	IF filter width {page 40}

Note:

- ◆ The COMP meter functions only when the Speech Processor is ON for SSB, FM, or AM mode.
- ◆ Peak Hold readings cannot be deactivated.
- ◆ The S-meter responds differently in FM mode, compared to other modes. This is not a malfunction.

TRANSMITTING

For voice communications, press and hold Mic [PTT] and speak into the microphone in your normal voice. When you finish speaking, release Mic [PTT] to receive.

To transmit CW, press [VOX (REV)] to turn the Break-in function ON. "VOX" appears. Close the key or keyer paddle. Connect a key or keyer paddle {page 2}, then select CW using [CW/FSK (REV)].

For a detailed explanation on transmitting, refer to "BASIC COMMUNICATIONS", beginning on page 21.

SELECTING TRANSMISSION POWER

It is wise to select a lower transmission power if communication is still reliable. This lowers the risk of interfering with others on the band. When operating from battery power, selecting a lower transmission power allows you more operating time before recharging is necessary. This transceiver allows you to change the transmission power even while transmitting.

- 1 Press [PWR (TX MONI)].

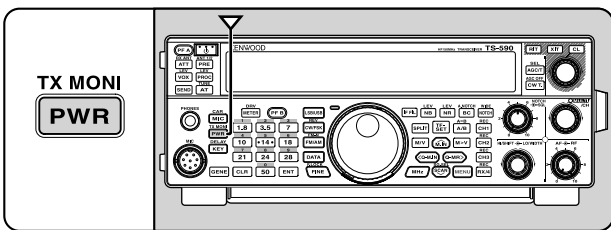

- The current transmission power appears.

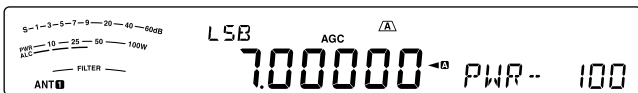

- 2 Turn the MULTI/CH control counterclockwise to reduce the power or clockwise to increase the power.

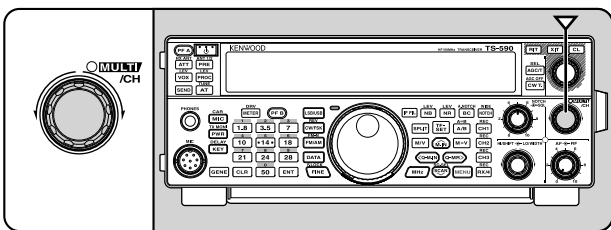

- 3 Press [PWR (TX MONI)] or [CLR] to complete the setting.

Note: You can access Menu No. 54, and select "on" to change the step size from 5 W to 1 W {page 58}.

MICROPHONE GAIN

The microphone gain must be adjusted when SSB or AM mode is selected without using the speech processor {pages 21, 22}.

- 1 Press [MIC (CAR)].

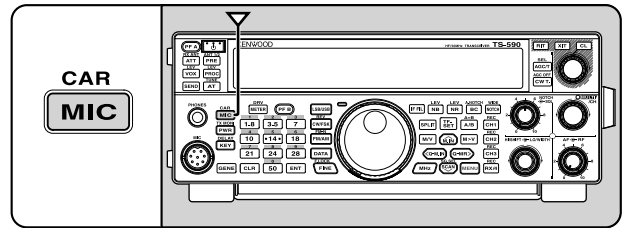

- The current microphone gain level appears. The range is from 0 to 100 with a default of 50.



- 2 Press and hold Mic [PTT].
 - The TX-RX LED lights red.
- 3 SSB: While speaking into the microphone, adjust the MULTI/CH control so that the ALC meter reflects your voice level but does not exceed the ALC limit.

AM: While speaking into the microphone, adjust the MULTI/CH control so that the power meter slightly reflects your voice level.

FM: Access Menu No. 53 and select "1" (Normal), "2" (Medium), or "3" (High) for the microphone gain if necessary {page 21}.

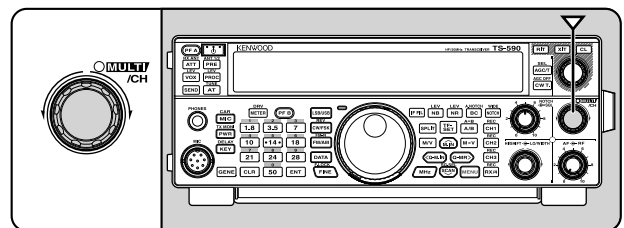

- 4 Release Mic [PTT].
 - The TX-RX LED lights green or turns off, depending on the SQL control setting.
- 5 Press [MIC (CAR)] or [CLR] to exit the Microphone gain adjustment.

Note: When using the MC-90 microphone in FM mode, select "3" (High) for the microphone gain. The microphone sensitivity is low in FM mode. This may cause insufficient modulation. For other microphones, select either "1" (Normal) or "2" (Medium).

4 MENU SETUP

WHAT IS A MENU?

Many functions on this transceiver are selected or configured via a software-controlled Menu, rather than through the physical controls of the transceiver. Once familiar with the Menu system, you will appreciate the versatility it offers. You can customize the various timings, settings, and programming functions on this transceiver to meet your needs without using many controls and switches.

MENU A/ MENU B

This transceiver has 2 menus: Menu A and Menu B. These menus contain identical functions and can be configured independently. The transceiver, therefore, allows you to switch between 2 different environments quickly and easily. For example, you can configure Menu A for DXing and contesting while Menu B is for relaxed local ragchewing. By switching from Menu A to Menu B, you can instantly change the Menu configuration and key assignment to suit your current operating style. Or, 2 operators may share a single transceiver by dedicating one Menu to each operator. Both operators can always enjoy their own configuration.

MENU ACCESS

- 1 Press [MENU].
 - The Menu No. and setting appear on the display, and the explanation of the menu appears on the sub-display.

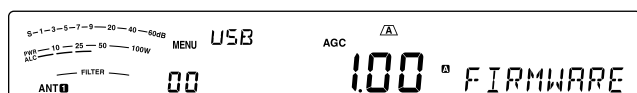

- 2 Press [A/B (A=B)] to select Menu A or B.
 - “A” or “B” appears, indicating which Menu is selected.
- 3 Press [Q-M.IN]/ [Q-MR] or turn the MULTI/CH control to select the desired Menu No.
 - Each time you change the Menu No., a different scrolling message appears on the sub-display, describing the Menu No.
- 4 Press [M.IN]/ [SCAN (SG.SEL)], or Mic [UP]/ [DWN] to select a parameter.

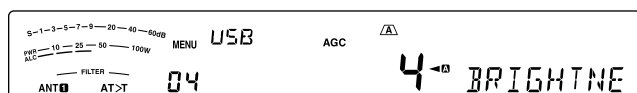

- 5 Press [MENU] to exit Menu mode.

QUICK MENU

Because the number of functions this transceiver provides is extraordinary, there are numerous items in each Menu. If you find accessing desired Menu Nos. to be too time consuming, use the Quick Menu to create your own customized, abbreviated Menu. You can then add those Menu Nos. which you frequently use, to the Quick Menu. Copying Menu Nos. to the Quick Menu has no effect on the Menu.

PROGRAMMING THE QUICK MENU

- 1 Press [MENU].
- 2 Press [Q-M.IN]/ [Q-MR] or turn the MULTI/CH control to select the desired Menu No.
- 3 Press [FINE (F.LOCK)].
 - “★” appears, indicating that the Menu item has been added to the Quick Menu.

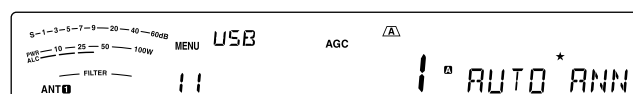

- 4 To remove the item from the Quick Menu, press [FINE (F.LOCK)] again. “★” disappears.
- 4 Press [MENU] to exit Menu mode.

USING THE QUICK MENU

- 1 Press [MENU].
- 2 Press [MHz].
 - “MHz” appears.

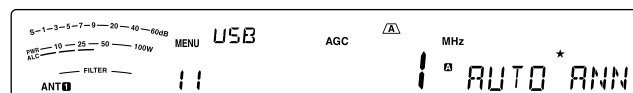

- 3 Press [Q-M.IN]/ [Q-MR] or turn the MULTI/CH control to select the desired Quick Menu No.
- 4 Press [M.IN]/ [SCAN (SG.SEL)], or Mic [UP]/ [DWN] to change the current setting for the selected Menu No.
 - When the Menu is registered to the Quick Menu list, “★” appears.
- 5 Press [MENU] to exit Quick Menu mode.

Note: If the Quick Menu has not been programmed, Press [Q-M.IN]/[Q-MR] or turning the MULTI/CH control in step 2 causes “CHECK” to be output in Morse code.

MENU CONFIGURATION

Category	No.	Description	Settings**	Ref. Page
		Display*	Default**	
Operator Interface	00	Firmware version	-	79
		FIRMWARE VERSION		
	01	Power on message	HELLO/ EDIT	68
		POWER ON MESSAGE	KENWOOD	
	02	Display brightness	OFF/ 1 ~ 6	55
		Off, 1: minimum, 6: maximum		
	03	Display backlight color	1 ~ 10	55
		1: amber, 2 ~ 9: mixed colors, 10: green		
04	Panel key response for double function	1/ 2/ 3	55	
	1: 0.2 second, 2: 0.5 second, 3: 1 second			2
Volume	05	Beep output level	OFF/ 1 ~ 20 (1 step)	54
		OFF, 1: minimum, 20: maximum		
	06	Sidetone volume	OFF/ 1 ~ 20 (1 step)	23, 36
		OFF, 1: minimum, 20: maximum		
	07	VGS-1 message playback volume	OFF/ 1 ~ 20 (1 step)	63
		OFF, 1: minimum, 20: maximum		
Voice Guide	08	VGS-1 announcement volume	OFF/ 1~ 20 (1 step)	66
		OFF, 1: minimum, 20: maximum		
	09	VGS-1 announcement speed	0 ~ 4 (1 step)	66
		0: slow, 4: fast		
	10	VGS-1 announcement language	EN/ JP	66
		EN: English, JP: Japanese		
	11	VGS-1 auto announcement	OFF/ 1/ 2	63
		AUTO ANNOUNCEMENT		
Tuning	12	MHz step	0.1/ 0.5/ 1 [MHz]	29
		MHZ STEP		
	13	Tuning control adjustment rate	250/ 500/ 1000 [Hz]	30
		TUNING CONTROL CHANGE RATE PER REVOLUTION		
	14	Rounds off VFO frequencies changed by using the MULTI/CH control	OFF/ ON	29
		FREQUENCY ROUNDING OFF WHEN USING MULTI/CH CONTROL		

4 MENU SETUP

Category	No.	Description	Settings**	Ref. Page
		Display*	Default**	
Tuning (continued)	15	9 kHz frequency step size for the MULTI/CH control in AM mode on the AM broadcast band	OFF/ ON	29
		MULTI/CH CONTROL 9KHZ STEP CHANGE IN AM BROADCAST BAND	K type: OFF E type: ON	
	16	Frequency step size for the MULTI/CH control in SSB mode	OFF/ 0.5/ 1/ 2.5/ 5/ 10 [kHz]	29
		MULTI/CH CONTROL	5	
	17	Frequency step size for the MULTI/CH control in CW/ FSK mode	OFF/ 0.5/ 1/ 2.5/ 5/ 10 [kHz]	29
		CW MULTI/CH CONTROL	0.5	
	18	Frequency step size for the MULTI/CH control in AM mode	OFF/ 5/ 6.25/ 10/ 12.5/ 15/ 20/ 25/ 30/ 50/ 100 [kHz]	29
		AM MULTI/CH CONTROL	5	
	19	Frequency step size for the MULTI/CH control in FM mode	OFF/ 5/ 6.25/ 10/ 12.5/ 15/ 20/ 25/ 30/ 50/ 100 [kHz]	29
		FM MULTI/CH CONTROL	10	
20	Shiftable RX frequency during split transmission	OFF/ ON	25	
	SHIFTABLE RX FREQUENCY DURING SPLIT TRANSMISSION	OFF		
Memory Channel	21	Number of quick memory channels	3/ 5/ 10 [ch]	47
		NUMBER OF QUICK MEMORY CHANNELS	5	
	22	Tunable memory recall frequencies	OFF/ ON	44
TUNABLE MEMORY RECALL FREQUENCIES		OFF		
Scan	23	Program scan partially slowed	OFF/ ON	49
		PROGRAM SCAN PARTIALLY SLOWED	ON	
	24	Slow down frequency range for the program scan	100/ 200/ 300/ 400/ 500 [Hz]	49
		PROGRAM SLOW-SCAN RANGE	300	
	25	Program scan hold	OFF/ ON	50
		PROGRAM SCAN HOLD	OFF	
26	Scan resume method	TO/ CO	50	
	SCAN RESUME METHOD	TO		
Auto Mode	27	Auto mode operation	ON/ OFF	53
		AUTO MODE OPERATION	OFF	
DSP Function	28	SSB filter type selection	1/ 2	41
		SSB FILTER TYPE SELECTION	1 (HI/LO)	
	29	SSB DATA filter type selection	1/ 2	41
		SSB DATA FILTER TYPE SELECTION	2 (WIDTH/SHIFT)	
	30	Auto notch tracking speed	0 ~ 4 (1 step)	41
		AUTO NOTCH TRACKING SPEED	2	
	31	TX filter for SSB/AM low cut	10/ 100/ 200/ 300/ 400/ 500 [Hz]	33
		TX FILTER FOR SSB/AM LOW CUT	300	
32	TX filter for SSB/AM high cut	2500/ 2600/ 2700/ 2800/ 2900/ 3000 [Hz]	33	
	TX FILTER FOR SSB/AM HIGH CUT	2700		

Category	No.	Description	Settings**	Ref. Page	
		Display*	Default**		
DSP Function (continued)	33	TX filter for SSB-DATA low cut	10/ 100/ 200/ 300/ 400/ 500 [Hz]	33	
		TX FILTER FOR SSB-DATA LOW CUT	300		
	34	TX filter for SSB-DATA high cut	2500/ 2600/ 2700/ 2800/ 2900/ 3000 [Hz]	33	
		TX FILTER FOR SSB-DATA HIGH CUT	2700		
	35	Speech processor effect	SOFT/ HARD	32	
		SPEECH PROCESSOR EFFECT	HARD		
Equalizer	36	DSP TX equalizer oFF: Off, Hb1: High boost1, Hb2: High boost2, FP: Formant pass, bb1: Bass boost1, bb2: Bass boost2, c: Conventional, U: User (Reserved for ARCP software)	OFF/ HB1/ HB2/ FP/ BB1/ BB2/ C/ U	33	
		DSP TX EQUALIZER	OFF		
	37	DSP RX equalizer oFF: Off, Hb1: High boost1, Hb2: High boost2, FP: Formant pass, bb1 Bass boost1, bb2: Bass boost2, FLAT: Flat U: User (Reserved for ARCP software)	OFF/ HB1/ HB2/ FP/ BB1/ BB2/ FLAT/ U	57	
		DSP RX EQUALIZER	OFF		
	CW	38	Electronic keyer mode	A/ B	34
			ELECTRONIC KEYER MODE	B	
39		Keying priority over playback	OFF/ ON	35	
		KEYING PRIORITY OVER PLAYBACK	OFF		
40		CW RX pitch/ TX sidetone frequency	300 ~ 1000 (50 [Hz] step)	23	
		CW RX PITCH/TX SIDETONE FREQUENCY	800		
41		CW rise time	1/ 2/ 4/ 6 [ms]	35	
		CW RISE TIME	6		
42		CW keying dot, dash weight ratio	AUTO/ 2.5 ~ 4.0 (0.1 step)	35	
		CW WEIGHTING	AUTO		
43		Reverse CW keying auto weight ratio	OFF/ ON	35	
		REVERSED CW WEIGHTING	OFF		
44		Bug key function	OFF/ ON	35	
		BUG KEY FUNCTION	OFF		
45		Reversed dot and dash keying	OFF/ ON	37	
		REVERSED DOT AND DASH KEYING	OFF		
46	MIC UP/DWN key paddle function PF: PF key PA: Paddle	PF/ PA	37		
	MIC UP/DWN KEY FUNCTION	PF			
47	Auto CW TX when keying in SSB	OFF/ ON	37		
	AUTO CW TX WHEN KEYING IN SSB	OFF			
48	Frequency correction for changing SSB to CW	OFF/ ON	37		
	FREQUENCY CORRECTION FOR SSB-TO-CW CHANGE	OFF			

4 MENU SETUP

Category	No.	Description	Settings**	Ref. Page
		Display*	Default**	
CW (continued)	49	No Break-in operation while adjusting keying speed	OFF/ ON	34
		NO BREAK-IN OPERATION WHILE ADJUSTING KEYING SPEED	OFF	
FSK	50	FSK shift	170/ 200/ 425/ 850 [Hz]	39
		FSK SHIFT	170	
	51	FSK keying polarity	OFF/ ON	39
		REVERSED FSK KEY-DOWN POLARITY	OFF	
52	FSK tone frequency	1275/ 2125 [Hz]	39	
	FSK TONE FREQUENCY	2125		
FM	53	MIC gain for FM 1: Low, 2: Mid, 3: Hi	1 ~ 3	22
		FM MIC GAIN	1	
TX Control	54	Fine transmission power tuning	OFF/ ON	58
		FINE TRANSMIT POWER CHANGE STEPS	OFF	
	55	Time-out timer	OFF/ 3/ 5/ 10/ 20/ 30 (min)	58
		TIME-OUT TIMER	OFF	
Transverter	56	Xverter/ power down of Xverter	OFF/ 1/ 2	58
		XVERTER/ POWER DOWN OF XVERTER	OFF	
Antenna Tuner	57	TX hold when AT completes the tuning	OFF/ ON	52
		ANTENNA TUNER TX HOLD	OFF	
	58	In-line AT while receiving	OFF/ ON	52
		ANTENNA TUNER FOR RECEPTION	OFF	
Linear Amp	59	Linear amplifier control relay for HF band	OFF/ 1/ 2/ 3/ 4/ 5	55
		HF LINEAR AMPLIFIER CONTROL RELAY	OFF	
	60	Linear amplifier control relay for 50 MHz band	OFF/ 1/ 2/ 3/ 4/ 5	55
		50MHZ LINEAR AMPLIFIER CONTROL RELAY	OFF	
Message	61	Constant recording	OFF/ ON	63
		CONSTANT RECORDING	ON	
	62	Repeat the playback	OFF/ ON	35, 62
		PLAYBACK REPEAT	OFF	
	63	Interval time for repeating the playback	0 ~ 60 [s] (1 step)	35, 62
		PLAYBACK INTERVAL TIME	10	
Split/ Transfer	64	Split frequency transfer in master/ slave operation	OFF/ ON	60
		TRANSFER SPLIT FREQUENCY DATA TO ANOTHER TRANSCEIVER	OFF	
	65	Permit to write the transferred Split frequencies to the target VFOs	OFF/ ON	60
		COPY SPLIT FREQUENCY DATA TO VFO	OFF	
TX Inhibit	66	TX inhibit	OFF/ ON	33
		TX INHIBIT	OFF	

Category	No.	Description	Settings**	Ref. Page
		Display*	Default**	
PC (Communication)	67	COM port communication speed***	4800/ 9600/ 19200/ 38400/ 57600/ 115200	60
		COM PORT BAUDRATE	9600 (bps)	
	68	USB port communication speed***	4800/ 9600/ 19200/ 38400/ 57600/ 115200	60
		USB PORT BAUDRATE	115200 (bps)	
External Audio (Input/ Output)	69	Audio input line selection for data communications	ACC2/ USB	61
		AUDIO INPUT LINE SELECTION FOR DATA COMMUNICATIONS	ACC2	
	70	Audio source of SEND/PTT transmission for data mode	FRONT/ REAR	61
		SOURCE OF SEND/PTT TRANSMISSION	FRONT	
	71	Audio level of USB input for data communications	0 ~ 9 (1 step)	61
		AUDIO LEVEL OF USB INPUT FOR DATA COMMUNICATIONS	4	
	72	Audio level of USB output for data communications	0 ~ 9 (1 step)	61
		AUDIO LEVEL OF USB OUTPUT FOR DATA COMMUNICATIONS	4	
	73	Audio level of ACC2 input for data communications	0 ~ 9 (1 step)	61
		AUDIO LEVEL OF ACC2 INPUT FOR DATA COMMUNICATIONS	4	
	74	AUDIO level of ACC2 output for data communications	0 ~ 9 (1 step)	61
		AUDIO LEVEL OF ACC2 OUTPUT FOR DATA COMMUNICATIONS	4	
75	Mixing beep tones for ACC2/USB audio output	OFF/ ON	61	
	MIXING BEEP TONES FOR ACC2/USB AUDIO OUTPUT	OFF		
External Accessory Control	76	Data VOX	OFF/ ON	31
		VOX OPERATION WITH DATA INPUT	OFF	
	77	Data VOX delay time	0 ~ 100 (5 step)	32
		DATA VOX DELAY TIME	50	
	78	Data VOX gain for the USB audio input	0 ~ 9 (1 step)	32
		USB VOX GAIN	4	
	79	Data VOX gain for the ACC2 terminal	0 ~ 9 (1 step)	32
		ACC2 VOX GAIN	4	
	80	PKS polarity	OFF/ ON	66
		REVERSED PKS POLARITY	OFF	
	81	Busy lockout (TX)	OFF/ ON	33
		BUSY FREQUENCY TRANSMISSION LOCKOUT	OFF	
82	CTCSS mute control	1/ 2	61	
	CTCSS MUTE CONTROL	1		
83	PSQ control signal logic	LO/ OPEN	61	
	PSQ OUTPUT LOGIC	LO		

4 MENU SETUP

Category	No.	Description	Settings**	Ref. Page
		Display*	Default**	
External Accessory Control (continued)	84	PSQ source output condition	OFF/ BSY/ SQL/ SND/ BSY-SND/ SQL-SND	61
		PSQ SOURCE	SQL	
	85	DRV connector output function	DRO/ ANT	52
		DRV CONNECTOR FUNCTION	DRO	
Timer	86	APO (Auto Power Off) function	OFF/ 60/ 120/ 180 [min]	52
		AUTO POWER OFF	OFF	
PF Keys	87	Front panel PF A key assignment	0 ~ 99, 120 ~ 170, 200 ~ 209, OFF	56
		FRONT PANEL PF A KEY ASSIGNMENT	200 [VOICE1]	
	88	Front panel PF B key assignment	0 ~ 99, 120 ~ 170, 200 ~ 209, OFF	56
		FRONT PANEL PF B KEY ASSIGNMENT	201 [VOICE2]	
	89	Front panel RIT key assignment	0 ~ 99, 120 ~ 170, 200 ~ 209, OFF	56
		RIT KEY ASSIGNMENT	165 [RIT]	
	90	Front panel XIT key assignment	0 ~ 99, 120 ~ 170, 200 ~ 209, OFF	56
		XIT KEY ASSIGNMENT	166 [XIT]	
	91	Front panel CL key assignment	0 ~ 99, 120 ~ 170, 200 ~ 209, OFF	56
		CL KEY ASSIGNMENT	167 [CL]	
	92	Front panel MULTI/CH key assignment	0 ~ 99, 120 ~ 170, 200 ~ 209, OFF	56
		MULTI CH KEY ASSIGNMENT	131 [PWR]	
	93	Front panel MULTI/CH key assignment (CW)	0 ~ 99, 120 ~ 170, 200 ~ 209, OFF	56
		CW MULTI CH KEY ASSIGNMENT	133 [KEY]	
	94	Microphone PF 1 key assignment	0 ~ 99, 120 ~ 170, 200 ~ 209, OFF	56
		MIC PF 1 KEY ASSIGNMENT	151 [A/B]	
	95	Microphone PF 2 key assignment	0 ~ 99, 120 ~ 170, 200 ~ 209, OFF	56
		MIC PF 2 KEY ASSIGNMENT	148 [SPLIT]	
	96	Microphone PF 3 key assignment	0 ~ 99, 120 ~ 170, 200 ~ 209, OFF	56
		MIC PF 3 KEY ASSIGNMENT	154 [M>V]	
97	Microphone PF 4 key assignment	0 ~ 99, 120 ~ 170, 200 ~ 209, OFF	56	
	MIC PF 4 KEY ASSIGNMENT	203 [MONITOR]		
98	Microphone DWN key assignment	0 ~ 99, 120 ~ 170, 200 ~ 209, OFF	56	
	MIC DOWN KEY ASSIGNMENT	207 [DOWN]		
99	Microphone UP key assignment	0 ~ 99, 120 ~ 170, 200 ~ 209, OFF	56	
	MIC UP KEY ASSIGNMENT	208 [UP]		

* The bolded lettering of the display message is what appears on the display while paused.

** Settings and default values may be modified.

*** After changing this setting via the menu, turn the power OFF and then back ON to implement the change.

5 BASIC COMMUNICATIONS

SSB TRANSMISSION

SSB is the most commonly-used mode on the HF Amateur radio bands. Compared with other voice modes, SSB requires only a narrow bandwidth for communications. SSB also allows long distance communications with minimum transmission power.

If necessary, refer to “OPERATING BASICS”, beginning on page 10, for details on how to receive.

- 1 Select an operating frequency.
- 2 Press **[LSB/USB]** until “USB” or “LSB” appears on the operating mode display.
 - If the desired sideband (“USB” or “LSB”) does not appear, select the other sideband first. Then, press **[LSB/USB]**. The mode indicator changes to your desired sideband.
 - “USB” represents the upper sideband and “LSB” represents the lower sideband. Normally, USB is used for the communications for 10 MHz and above while LSB is used for the frequencies below 10 MHz.



- 3 Press **[MIC (CAR)]** to adjust the Microphone gain.
 - The current gain level appears on the sub-display.



- 4 Press and hold Mic **[PTT]**.
 - The TX-RX LED lights red.
 - Refer to “VOX” {page 31} for information on automatic TX/ RX switching.
- 5 Speak into the microphone and turn the **MULTI/CH** control so that the ALC meter reflects your voice level but does not exceed the ALC limit.
 - Speak in your normal tone and level of voice. Speaking too close to the microphone or too loudly may increase distortion and reduce intelligibility at the receiving end.
 - You may want to use the Speech Processor. Refer to “SPEECH PROCESSOR” {page 32} for details.
- 6 Release Mic **[PTT]** to return to Reception mode.
 - The TX-RX LED lights green or turns off, depending on the **SQL** control position.
- 7 Press **[MIC (CAR)]** or **[CLR]** to exit the Microphone gain adjustment.

Refer to “COMMUNICATING AIDS”, beginning on page 29, for information on additional useful operation functions.

AM TRANSMISSION

Each mode used on the HF Amateur bands has its own advantages. Although long distance DX contacts may be less common while using AM, the superior audio quality characteristic of AM operation is one reason why some hams prefer this mode.

If necessary, refer to “OPERATING BASICS”, beginning on page 10, for details on how to receive.

- 1 Select an operating frequency.
- 2 Press **[FM/AM (FM-N)]** until “AM” appears.
 - If “AM” does not appear, select “FM” first, then press **[FM/AM (FM-N)]**. The mode indicator changes to “AM”.



- 3 Press **[MIC (CAR)]** to enter the Microphone gain adjustment mode.
 - The current gain level appears on the sub-display.
- 4 Press and hold Mic **[PTT]**.
 - The TX-RX LED lights red.
 - Refer to “VOX” {page 31} for information on automatic TX/ RX switching.
- 5 Speak into the microphone and adjust the **MULTI/CH** control so that the power meter slightly reflects your voice level.
 - Speak in your normal tone and level of voice. Speaking too close to the microphone or too loudly may increase distortion and reduce intelligibility at the receiving end.
 - You may want to use the Speech Processor. Refer to “SPEECH PROCESSOR” {page 32} for details.
- 6 Release Mic **[PTT]** to return to Reception mode.
 - The TX-RX LED lights green or turns off, depending on the **SQL** control position.
- 7 Press **[MIC (CAR)]** or **[CLR]** to exit the Microphone gain adjustment mode.

Refer to “COMMUNICATING AIDS”, beginning on page 29, for information on additional useful operation functions.

Note: When the TX power meter reading exceeds the value that you specified in the TX Power setting {page 58}, decrease the microphone gain or adjust your tone and level of voice.

5 BASIC COMMUNICATIONS

FM TRANSMISSION

FM is a common mode for communicating on VHF or UHF frequencies. As for HF and the 6 m band, 29 MHz and 51-54 MHz bands are commonly used for FM operation. You can also utilize 10 m/ 6 m band repeaters to reach your friends when they are outside or skipped over from your coverage. Although FM requires a wider bandwidth when compared to SSB or AM mode, it has the finest audio quality among these modes. When combined with the full-quieting aspect of FM signals, which suppresses background noise on the frequency, FM can be the best method for maintaining casual communications with your local friends.

If necessary, refer to “OPERATING BASICS”, beginning on page 10, for details on how to receive.

- 1 Select an operating frequency.
- 2 Press **[FM/AM (FM-N)]** until “FM” appears.
 - If “FM” does not appear, select “AM”, then press **[FM/AM (FM-N)]**. The mode indicator changes to “FM”.



- 3 Press and hold Mic **[PTT]**.
 - The TX-RX LED lights red.
 - Refer to “VOX” {page 31} for information on automatic TX/ RX switching.
- 4 Speak into the microphone in your normal voice.
 - Speaking too close to the microphone or too loudly may increase distortion and reduce intelligibility at the receiving end.
 - You can switch the Microphone gain for FM between 1 (Normal), 2 (Medium), and 3 (High) by using Menu No. 53. 1 (Normal) is usually appropriate; however, select 3 (High) if other stations report that your modulation is weak.
- 5 Release Mic **[PTT]** to return to Reception mode.
 - The TX-RX LED lights green or turns off, depending on the **SQL** control position.

Refer to “COMMUNICATING AIDS”, beginning on page 29, for additional information on useful operation functions.

Note: Microphone gain adjustment for SSB or AM has no effect in FM mode. In FM mode, you must select 1 (Normal), 2 (Medium), or 3 (High) in Menu No. 53.

NARROW BANDWIDTH FOR FM

Select wide band or narrow band TX deviation depending on whether the other station is using wide band or narrow band filter for FM mode. While “NAR” appears, the TS-590SG transceiver transmits signals in narrow band FM but the reception IF filter bandwidth remains unchanged (Wide). The deviation selection is crucial to avoid audio distortion or insufficient intelligibility that the other station will encounter.

- 1 Press **[FM/AM (FM-N)]** until “FM” appears.
 - If “FM” does not appear, select “AM” first, then press **[FM/AM (FM-N)]**. The mode indicator changes to “FM”.
- 2 Press and hold **[FM/AM (FM-N)]** to toggle the selection between wide and narrow TX deviation.
 - “NAR” appears when narrow TX deviation is selected.



CW TRANSMISSION

CW operators know that this mode is very reliable when communicating under worst conditions. It may be true that newer digital modes rival CW as being equally as useful in poor conditions. These modes, however, do not have the long history of service nor the simplicity that CW provides.

This transceiver has a built-in electronic keyer that supports a variety of functions. For details on using these functions, refer to “ELECTRONIC KEYS” {page 34}.

If necessary, refer to “OPERATING BASICS”, beginning on page 10, for details on how to receive.

- 1 Select the operating frequency.
- 2 Press **[CW/FSK (REV)]** until “CW” appears.
 - If “CW” does not appear, select “FSK” first, then press **[CW/FSK (REV)]**. The mode indicator changes to “CW”.
 - To precisely tune in another station, use Auto Zero-beat. Refer to “AUTO ZERO-BEAT” {page 23}.



- 3 Press **[SEND]**.
 - The TX-RX LED lights red.
- 4 Operate the Keys or Paddle.
 - As you transmit, you should hear a sidetone that lets you monitor your own transmission.
- 5 Press **[SEND]** to return to Reception mode.
 - The TX-RX LED lights green or turns off, depending on the **SQL** control setting.

AUTO ZERO-BEAT

Use Auto Zero-beat before transmitting to tune in a CW station. Auto Zero-beat automatically and exactly matches your transmit frequency with the station you are receiving. Neglecting to do this will reduce your chances of being heard by the other station.

- 1 Tune to the CW signal using the **Tuning** control.
- 2 Press **[CW T. (AGC OFF)]** to start Auto Zero-beat while CW is selected for the operating mode.
 - “CW TUNE” appears.



- Your reception frequency automatically changes so that the pitch (tone) of the received signal exactly matches the TX sidetone/ RX pitch frequency that you have selected. Refer to “TX SIDETONE/ RX PITCH FREQUENCY” {below}.
 - When matching is completed, “CW TUNE” disappears.
 - If matching is unsuccessful, the previous frequency is restored.
- 3 To quit Auto Zero-beat, press **[CW T. (AGC OFF)]** or **[CLR]**.

Note:

- ◆ When using Auto Zero-beat, the matching error is normally within ± 5 Hz.
- ◆ Auto Zero-beat may fail if the keying speed of the target station is too slow or if some interference is present.
- ◆ When the RIT function is ON, only RIT frequencies change to make the Auto Zero-beat adjustment.

TX SIDETONE/ RX PITCH FREQUENCY

As you send CW, you will hear tones from the transceiver speaker. These are called TX (transmission) sidetones. Listening to these tones, you can monitor what you are transmitting. You may also use the tones to ensure that your key contacts are closing, the keyer is functioning, or to practice sending without actually putting a signal on the air.

RX (reception) pitch refers to the frequency of CW that you hear after tuning in a CW station.

On this transceiver, the frequency of the sidetone and RX pitch are equal and selectable. Access Menu No. 40 to select the frequency that is most comfortable for you. The selectable range is from 300 Hz to 1000 Hz in steps of 50 Hz (default is 800 Hz).

To change the volume of the TX sidetone, access Menu No. 06. The selections range from 1 to 20 and OFF (default is 10).

Note:

- ◆ The position of the **AF** control does not affect the volume of the TX sidetone.
- ◆ When changing the CW pitch/ side tone, the shift amount of the receive filter is automatically applied to the CW pitch/ side tone. (In Quick Memory mode, the CW pitch/ side tone is not revised since the receive filter information stored in the Quick Memory has priority.)

CARRIER LEVEL

When using AM, CW, or FSK mode, you can adjust the carrier level.

- 1 Press and hold **[MIC (CAR)]**.
 - The current gain level appears on the sub display.

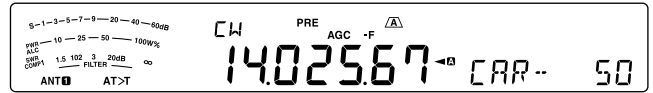

- 2 Turn the **MULTI/CH** control so that the ALC meter reads within the limits of the ALC zone.
 - For AM mode, adjust the **MULTI/CH** control so that the ALC meter just begins to indicate.
- 3 Press and hold **[MIC (CAR)]** again or press **[CLR]** to complete the setting.

6 ENHANCED COMMUNICATIONS

SPLIT-FREQUENCY OPERATION

Usually you can communicate with other stations using a single frequency for receiving and transmitting. In this case, you select only one frequency on either VFO A or VFO B. However, there are cases where you must select one frequency for receiving and a different frequency for transmitting. This requires the use of 2 VFOs. This is referred to as “split-frequency operation”. One typical case which requires this type of operation is when you use an FM repeater {page 25}. Another typical case is when you call a rare DX station.

When a rare or desirable DX station is heard, that operator may immediately get many simultaneous responses. Often, such a station is lost under the noise and confusion of many calling stations. If you find that you are suddenly being called by many operators, it is your responsibility to control the situation. You may announce that you will be “listening up 5 (kHz, from your present transmission frequency)”, or “listening down between 5 and 10 (kHz)”.

- 1 Press **[A/B (A=B)]** to select VFO A or VFO B.
 - “◀A” or “◀B” appears to show which VFO is selected.
- 2 Select an operating frequency.
 - This frequency will be used for transmission.
 - To copy the selected VFO frequency to the other VFO, press and hold **[A/B (A=B)]**.
- 3 Press **[A/B (A=B)]** to select the other VFO.
- 4 Select an operating frequency.
 - This frequency will be used for reception.
- 5 Press **[SPLIT]**.
 - “SPLIT” appears.
 - Each time you press **[A/B (A=B)]**, the reception and transmission frequencies are swapped.



- 6 To quit split-frequency operation, press **[SPLIT]** again.
 - “SPLIT” disappears.

DIRECTLY ENTERING THE FREQUENCY SPLIT SPECIFIED BY A DXer

To directly enter the difference between the TX and RX frequencies specified by a DXer, follow the instruction below while receiving on the main band of a signal from the DXer.

- 1 Press and hold **[SPLIT]**.
 - “SPLIT” blinks.
- 2 Enter the frequency difference (the “split”) in the order of kHz as specified by the DX station.
 - If the frequency specified by the DXer is higher than your current frequency, enter the specified frequency in the order of kHz using the numeric and band-select keypad. Conversely, if the

specified frequency is lower, prefix a value of “0” to the frequency.

- For example, enter a value “5” if you need to increment the frequency by 5 kHz, and enter a value “05” if you need to decrement the frequency by 5 kHz. When the input is completed, the transmitted frequency is set, split operation is enabled, and “SPLIT” stops blinking and remains lit.

TURN THE TUNING CONTROL TO SEARCH FOR THE TRANSMIT FREQUENCY

To directly search for the transmit frequency by rotating the **Tuning** control, follow the instruction below while receiving on the main band of a signal from the DX station.

- 1 Press and hold **[SPLIT]**.
 - “SPLIT” blinks.
- 2 Turn the **Tuning** control to search for the frequency.
 - Press **[CLR]** to stop searching.
- 3 Press **[SPLIT]** to end.
 - The frequency is configured as the transmit frequency and split operation begins.
 - “SPLIT” lights.

TF-SET (TRANSMISSION FREQUENCY SET)

TF-SET allows you to temporarily switch your transmission frequency and reception frequency. Canceling this function immediately restores the original transmission and reception frequencies. By activating TF-SET, you can listen on your transmit frequency, and change it while listening. This allows you to check whether or not the newly selected transmission frequency is free of interference.

- 1 Configure split-frequency operation as explained in the previous section.
- 2 Press and hold **[TF-SET]**, then turn the **Tuning** control or press Mic **[UP]/ [DWN]** to change the transmission frequency.



- The transceiver receives on the frequency as you change, but the frequency shown on the sub-display (the original reception frequency) stays unchanged.
- 3 Release **[TF-SET]**.
 - You are now receiving again on your original reception frequency.

Successfully contacting a DX station in a pileup often depends on making a well-timed call on a clear frequency. That is, it is important to select a relatively clear transmission frequency and to transmit at the exact instant when the DX station is listening but the majority of the groups aren't transmitting. Switch your reception and transmission frequencies by using the TF-SET function and listen to your transmission

frequency. You will soon learn the rhythm of the DX station and the pileup. The more proficient you become at using this function, the more DX stations you will contact.

Note:

- ◆ TF-SET is disabled while transmitting.
- ◆ You can change the transmission frequency even when the Frequency lock function is ON.
- ◆ An RIT offset frequency is not added; however, an XIT offset frequency is added to the transmit frequency during TF-SET.
- ◆ The TF-SET function does not operate in Simplex mode. However, when the XIT function is ON and the RIT function is OFF, the TF-SET function will operate in Simplex mode. In this situation, you can set the XIT frequency while operating TF-SET by rotating the Tuning knob or pressing the MIC [UP] / MIC [DOWN] keys.

SHIFTABLE RX FREQUENCY DURING SPLIT TRANSMISSION

As the factory default setting, when rotating the Tuning knob during split transmission, the transmit frequency will change. By following the procedures below, when rotating the Tuning knob during split transmission, you can change the receive frequency.

- 1 Press [MENU], then press [Q-M.IN]/[Q-MR] or turn the MULTI/CH control to select Menu No. 20.
- 2 Press [M.IN]/[SCAN (SG.SEL)] to select “on”
- 3 Press [MENU] to exit Menu mode.
 - When you switch the transceiver ON while this function is set to ON, the decimal point at the right end digit of the main display flashes for approximately 2 seconds after the Power On message is displayed.

FM REPEATER OPERATION

Most Amateur radio voice repeaters use a separate reception and transmission frequency. The transmission frequency may be higher or lower than the reception frequency. In addition, some repeaters may require the transceiver to transmit a subtone before the repeater can be used.

Compared to simplex communication, you can usually transmit over much greater distances by using a repeater. Repeaters are typically located on a mountain top or other elevated location. Often they operate at higher ERP (Effective Radiated Power) than a typical station. This combination of elevation and high ERP allows communications over considerable distances.

HF/ 6 m band repeaters usually operate in the 29 MHz FM sub-band and 51-54 MHz band. This special service combines the advantages of FM operation, good fidelity with noise and interference immunity, with the excitement of HF DX (long distance) communications. Even on a quiet day, 10 m FM provides reliable around-town communications with the potential for sudden DX from across the country or around the world.

Note:

- ◆ When programming 2 separate frequencies using 2 VFOs, be sure to select FM mode on both VFOs.
- ◆ When operating through a repeater, over deviation caused by speaking too loudly into the microphone can cause your signal to “talk-off” (break up) through the repeater.

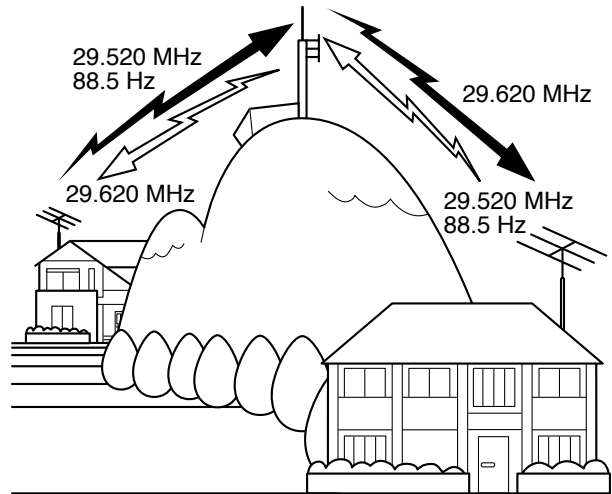

- 1 Press [A/B (A=B)] to select VFO A or VFO B.
 - “◀A” or “◀B” appears to show which VFO is selected.
- 2 Turn the Tuning control or the MULTI/CH control to select the reception frequency.
- 3 Press [FM/AM (FM-N)] to select FM mode.
- 4 Press and hold [A/B (A=B)] to duplicate the frequencies and other data to the other VFO.
- 5 Turn the Tuning control or the MULTI/CH control to select the transmission frequency.
- 6 Press [AGC/T (SEL)] to turn the Tone function ON if the repeater requires a subtone.
 - “T” appears.
 - Refer to “Selecting a Tone Frequency” for more details on the subtone {page 26}.

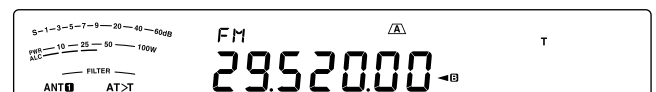

- To quit the Subtone function, press [AGC/T (SEL)] twice.
- 7 Press [SPLIT].
 - “SPLIT” appears.
 - 8 Press [A/B (A=B)] to return to the original reception frequency.

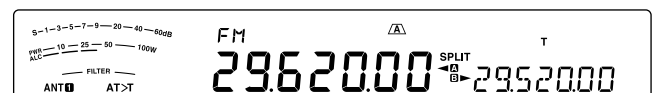

- 9 Press Mic [PTT] to transmit.
 - The VFO changes to the other VFO to transmit.
 - Each time you press [A/B (A=B)], the reception and transmission frequencies are swapped.
- 10 Press [SPLIT] to quit split-frequency operation.
 - “SPLIT” disappears.

6 ENHANCED COMMUNICATIONS

The data that you select in steps 1 to 8 can be stored in memory. Refer to “Split-Frequency Channels” {page 43}.

Note:

- ◆ When operating through a repeater, over deviation caused by speaking too loudly into the microphone can cause your signal to “talk-off” (break up) through the repeater.
- ◆ To check the tone frequency stored in a memory channel, recall the desired memory channel and press [**AGC/T (SEL)**].

TRANSMITTING A TONE

In general, FM repeaters require the transceiver to transmit a sub-audible tone to prevent other repeaters on the same frequency from locking each other up. The required tone frequency differs among repeaters. Repeaters also differ in their requirements for either continuous or burst tones. For the appropriate selections for your accessible repeaters, consult your local repeater reference.

After completing the tone settings, pressing and holding Mic [**PTT**] causes the transceiver to transmit the selected tone. If you have selected a 1750 Hz tone, the transceiver sends a 500 ms tone burst each time transmission starts.

Note: If you store tone settings in a memory channel, you need not reprogram each time. Refer to “MEMORY FEATURES” {page 43}.

■ Activating the Tone Function

- 1 Confirm that FM mode has been selected on the VFO(s) {page 10}.
 - When using 2 VFOs, you must select FM mode on both VFOs.
- 2 Press [**AGC/T (SEL)**].
 - “**T**” appears.

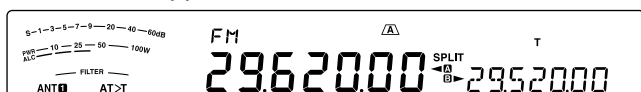

Note: You cannot use the Tone function with the CTCSS function.

■ Selecting a Tone Frequency

- 1 While “**T**” appears (Tone function is ON), press and hold [**AGC/T (SEL)**].
 - The current tone frequency appears. The default is 88.5 Hz.

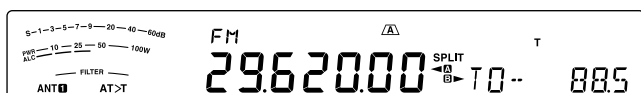

- 2 Turn the **MULTI/CH** control to select the desired tone frequency.
 - The available tone frequencies are listed in the table below.
- 3 Press and hold [**AGC/T (SEL)**] or press [**CLR**] to complete the setting.

No.	Freq. (Hz)	No.	Freq. (Hz)	No.	Freq. (Hz)	No.	Freq. (Hz)
00	67.0	11	97.4	22	141.3	33	206.5
01	69.3	12	100.0	23	146.2	34	210.7
02	71.9	13	103.5	24	151.4	35	218.1
03	74.4	14	107.2	25	156.7	36	225.7
04	77.0	15	110.9	26	162.2	37	229.1
05	79.7	16	114.8	27	167.9	38	233.6
06	82.5	17	118.8	28	173.8	39	241.8
07	85.4	18	123.0	29	179.9	40	250.3
08	88.5	19	127.3	30	186.2	41	254.1
09	91.5	20	131.8	31	192.8	42	1750
10	94.8	21	136.5	32	203.5	--	--

Note:

- ◆ You can select a tone frequency independent of a CTCSS frequency.
- ◆ When 1750 Hz is selected, the transceiver sends a 500 ms tone burst each time transmission starts. You cannot transmit 1750 Hz tone manually.

TONE FREQUENCY ID SCAN

This function scans through all tone frequencies to identify the incoming tone frequency on a received signal. You may find this useful when you do not know the tone frequency that the repeater uses.

- 1 While the Tone function is ON (“**T**” is visible), press and hold [**AGC/T (SEL)**].
 - The current tone frequency appears.
- 2 Press [**SCAN (SG.SEL)**] to activate the Tone frequency ID scan.
 - While the transceiver is receiving a signal, “**T**” blinks and every tone frequency is scanned. When the tone frequency is identified, the transceiver stops scanning and the identified frequency is displayed.

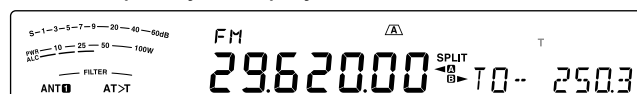

- Press [**SCAN (SG.SEL)**] or [**CLR**] to stop scanning while the tone frequency ID scan is active.
- Press [**SCAN (SG.SEL)**] again to resume scanning.

Note: Received signals are audible while scanning is in progress.

FM CTCSS OPERATION

You may sometimes want to hear calls only from specific persons. When using FM mode, the Continuous Tone Coded Squelch System (CTCSS) allows you to ignore (not hear) unwanted calls from other persons who are using the same frequency. A CTCSS tone is sub-audible and is selectable from among the 42 tone frequencies. Select the same CTCSS tone as the other stations in your group. You will not hear calls from stations other than those using the same CTCSS tone.

Note: CTCSS does not cause your conversation to be private. It only relieves you from listening to unwanted conversations.

- 1 Press **[A/B (A=B)]** to select VFO A or VFO B.
 - “◀A” or “◀B” appears to show which VFO is selected.
- 2 Select the 29 MHz band or the 51-54 MHz band using **[28 (9)]** or **[50 (0)]**.
- 3 Select the desired frequency with the **Tuning** control or **MULTI/CH** control.
- 4 Press **[FM/AM (FM-N)]** to select FM mode.
- 5 Turn the **SQL** control to adjust the squelch.
- 6 Press **[AGC/T (SEL)]** until “CT” appears.



- 7 While “CT” is visible, press and hold **[AGC/T (SEL)]**.
 - The current CTCSS frequency appears (default is 88.5 Hz).

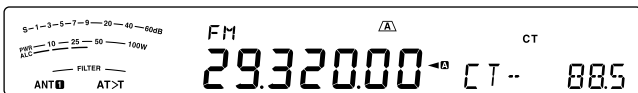

- 8 Turn the **MULTI/CH** control to select the appropriate CTCSS frequency.
 - The selectable CTCSS frequencies are listed in the table below.
- 9 Press and hold **[AGC/T (SEL)]** or press **[CLR]** to complete the setting.

No.	Freq. (Hz)	No.	Freq. (Hz)	No.	Freq. (Hz)	No.	Freq. (Hz)
00	67.0	11	97.4	22	141.3	33	206.5
01	69.3	12	100.0	23	146.2	34	210.7
02	71.9	13	103.5	24	151.4	35	218.1
03	74.4	14	107.2	25	156.7	36	225.7
04	77.0	15	110.9	26	162.2	37	229.1
05	79.7	16	114.8	27	167.9	38	233.6
06	82.5	17	118.8	28	173.8	39	241.8
07	85.4	18	123.0	29	179.9	40	250.3
08	88.5	19	127.3	30	186.2	41	254.1
09	91.5	20	131.8	31	192.8	--	--
10	94.8	21	136.5	32	203.5	--	--

You will hear calls only when the selected tone is received. To answer the call, press and hold Mic **[PTT]**, then speak into the microphone.

Skip steps 7 and 8 if you have already programmed the appropriate CTCSS frequency.

Note:

- ◆ When using split-frequency operation, select FM mode on both VFOs to use CTCSS.
- ◆ You can select a CTCSS frequency independent of a tone frequency.
- ◆ You cannot use the CTCSS function with the Tone function.

CTCSS FREQUENCY ID SCAN

This function scans through all CTCSS frequencies to identify the incoming CTCSS frequency on a received signal. You may find this useful when you cannot recall the CTCSS frequency that the other persons in your group are using.

- 1 While the CTCSS function is ON, press and hold **[AGC/T (SEL)]**.
 - The current CTCSS frequency appears.
- 2 Press **[SCAN (SG.SEL)]** to activate the CTCSS frequency ID scan.
 - While the transceiver is receiving a signal, “CT” blinks and every CTCSS frequency is scanned. When the CTCSS frequency is identified, the transceiver stops scanning and the identified frequency is displayed.

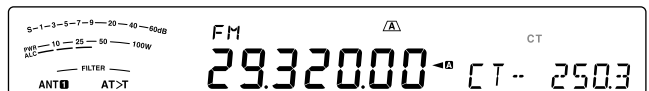

- Press **[SCAN (SG.SEL)]** or **[CLR]** to stop scanning while the CTCSS frequency ID scan is active.
- Press **[SCAN (SG.SEL)]** again to resume scanning.

Note: Received signals are audible while scanning is in progress.

6 ENHANCED COMMUNICATIONS

CROSS TONE

Use this feature when using different uplink and downlink tones to access a repeater. You can set a transmission Tone frequency and reception CTCSS frequency to different frequencies.

To set the transmission tone:

- 1 Press [**A/B (A=B)**] to select VFO A or VFO B.
- 2 Select your desired transmission frequency.
- 3 Press [**FM/AM (FM-N)**] to select FM.
- 4 Press [**AGC/T (SEL)**] until “T” appears.
- 5 Press and hold [**AGC/T (SEL)**], then turn the **MULTI/CH** control to select your desired Tone frequency.
- 6 Press and hold [**AGC/T (SEL)**] or press [**CLR**] to complete the setting.

To set the reception tone:

- 1 Press [**A/B (A=B)**] to select the other VFO.
- 2 Select your desired reception frequency.
- 3 Press [**FM/AM (FM-N)**] to select FM.
- 4 Press [**AGC/T (SEL)**] until “CT” appears.
- 5 Press and hold [**AGC/T (SEL)**], then turn the **MULTI/CH** control to select your desired CTCSS frequency.
- 6 Press and hold [**AGC/T (SEL)**] or press [**CLR**] to complete the setting.

To set the Cross tone:

- 1 Press [**SPLIT**].
 - “SPLIT” appears on the display.
- 2 Press [**AGC/T (SEL)**] until “CTx” appears.

Note: When the cross tone function is ON, the Tone and CTCSS frequency cannot be changed. To change the Tone or CTCSS frequency, press [**AGC/T (SEL)**] to turn Tone or CTCSS ON, then change the setting.

7 COMMUNICATING AIDS

RECEPTION

SELECTING YOUR FREQUENCY

In addition to turning the **Tuning** control or pressing Mic **[UP]/ [DWN]**, there are several other ways to select your frequency. This section describes additional methods of frequency selection that may save you time and effort.

■ Direct Frequency Entry

When the desired frequency is far removed from the current frequency, directly entering a frequency from the numeric keypad is usually the fastest method.

1 Press **[ENT]**.

- “- - - - -” appears.

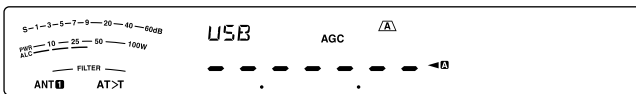

2 Press the numeric keys (**[50 (0)]** to **[28 (9)]**) to enter your desired frequency.

- Pressing **[ENT]** at any time fills the remaining digits (the digits you did not enter) with 0 and completes the entry. To select 1.85 MHz for example, press **[ENT]**, **[50 (0)]**, **[1.8 (1)]**, **[24 (8)]**, **[14 (5)]**, then press **[ENT]** to complete the input (6 key strokes).
- Pressing **[CLR]** before pressing **[ENT]** cancels the entry and restores the current VFO frequency.

Note:

- ◆ You can enter a frequency in the range of 30.00 kHz to 59.999.99 MHz. Refer to the specifications for the available frequency range.
- ◆ Attempting to enter a frequency that is outside the selectable frequency range causes an alarm to sound and the entered frequency is rejected.
- ◆ When the entered frequency does not meet the current VFO frequency step size requirement, the nearest available frequency is automatically selected after the entered frequency is changed.
- ◆ When the 10 Hz digit (last displayed digit) is entered, the digit 0 is automatically entered for the 1 Hz digit, and frequency entry is completed. The 1 Hz digit is not displayed.
- ◆ When an entered frequency is accepted, RIT or XIT will be switched OFF, but the RIT or XIT offset frequency is not cleared.

■ Frequency Entry History

The last 10 frequencies you entered are stored in the Frequency Entry History. You can access the history to easily re-enter a recently used frequency.

1 Press **[ENT]**.

2 Turn the **MULTI/CH** control.

- The entered frequency along with its log number appears. The most recent entered frequency is logged as number E0 and the oldest frequency is logged as number E9.

3 Press **[ENT]** to set the selected frequency to the VFO.

Note: When entering a frequency using the numeric keys, if you turn the **MULTI/CH** control in the middle of the frequency entry, the frequency will be entered into the log.

■ Using the MHz key

You can use the **MULTI/CH** control to change the operating frequency in steps of 1 MHz.

1 Press **[MHz]**.

- “MHz” appears.



2 Turn the **MULTI/CH** control.

- Clockwise increases the frequency and counter-clockwise decreases the frequency.

3 Press **[MHz]** again to exit.

- “MHz” disappears.

If you prefer to change the frequency in steps of 100 kHz or 500 kHz, rather than 1 MHz, access Menu No. 12 and select 100 kHz, 500 kHz, or 1 MHz.

Note: Even if 100 kHz or 500 kHz is assigned for the **[MHz]** key, “MHz” appears on the display.

■ Quick QSY

To move up or down the frequency quickly, use the **MULTI/CH** control. The default values are as follows: SSB/AM mode: 5 kHz, CW/FSK mode: 500 Hz, FM mode: 10 kHz

- If you want to change the default frequency step size, access Menu No. 16 (SSB), 17 (CW/FSK), 18 (AM), or 19 (FM). Press **[M.IN]/ [SCAN (SG. SEL)]** to select OFF, 500 Hz, 1 kHz, 2.5 kHz, 5 kHz, or 10 kHz for SSB/ CW/ FSK, and 5 kHz, 6.25 kHz, 10 kHz, 12.5 kHz, 15 kHz, 20 kHz, 25 kHz, 30 kHz, 50 kHz, or 100 kHz for AM/ FM.
- When changing the operating frequency by using the **MULTI/CH** control, frequencies are rounded such that new frequencies are multiples of the frequency step size. To disable this function, access Menu No. 14 and select “oFF” (default is ON).
- In the AM broadcast band the step size will automatically be set to 9 kHz when Menu No. 15 is ON.

Note:

- ◆ You can also set a different frequency step size for SSB, CW/FSK, AM and FM modes.
- ◆ When the menu is set to “oFF”, the **MULTI/CH** control is invalid in each mode.

7 COMMUNICATING AIDS

■ Fine Tuning

The default frequency step size when turning the **Tuning** control to change the frequency is 10 Hz for SSB/ CW/ FSK, and 100 Hz for AM/ FM. However, you can change the frequency step size to 1 Hz for SSB/ CW/ FSK, and 10 Hz for AM/ FM.

1 Press **[FINE (F.LOCK)]**.

- “FINE” appears.



2 Turn the **Tuning** control to select the exact frequency.

3 To quit the function, press **[FINE (F.LOCK)]** again.

- “FINE” disappears.

Note:

- ◆ If the Fine Tuning function is ON when the displayed frequency is less than 1MHz, the frequency is displayed up to the 1Hz digit but is shifted one position to the left (except when Menu No. 56 is set to “1” or “2”).
- ◆ The Fine Tuning function ON/OFF setting is stored in each of the following modes.
SSB/ SSB-DATA/ CW/ FSK/ FM/ AM

■ Tuning Control Adjustment Rate

The default **Tuning** control adjustment rate is 1000. This represents the number of pulses the **Tuning** control generates in a complete revolution. Each pulse changes the tuning frequency based on the current frequency step size (the frequency step size for the **Tuning** control is 10 Hz for SSB/ CW/ FSK and 100 Hz for AM/ FM). For example, in SSB mode the frequency step size is 10 Hz, so the frequency would change by 5,000 Hz in a complete revolution of the **Tuning** control. The adjustment rate of the **Tuning** control can be lowered to 250 pulses per revolution or increased to 1000 pulses per revolution.

1 Press **[MENU]**, then press **[Q-M.IN]/ [Q-MR]** or turn the **MULTI/CH** control to select Menu No. 13.

2 Press **[M.IN]/ [SCAN (SG.SEL)]** to select “250”, “500”, or “1000” (default).

3 Press **[MENU]** to exit Menu mode.

■ Equalizing VFO Frequencies (A=B)

This function allows you to copy the frequency and modulation mode of the active VFO to the inactive VFO.

1 Select the frequency and mode on VFO A or VFO B.

2 Press and hold **[A/B (A=B)]**.

- The frequency and mode selected in step 1 are duplicated to the inactive VFO.

3 Press **[A/B (A=B)]** to confirm that the frequency was copied to other VFO.

RIT (RECEIVE INCREMENTAL TUNING)

RIT provides the ability to change your reception frequency by ± 9.99 kHz in steps of 10 Hz without changing your transmission frequency. If the Fine Tuning (**[FINE (F.LOCK)]**) function is ON, the frequency step size becomes 1 Hz (± 9.999 kHz). RIT works equally well with all modulation modes and while using VFO or Memory Recall mode.

1 Press **[RIT]**.

- “RIT” and the RIT offset appear.

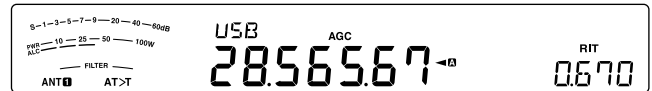

2 If required, press **[CL]** to reset the RIT offset to 0.

3 Turn the **RIT/ XIT** control to change your reception frequency.

4 To turn RIT OFF, press **[RIT]**.

- The reception frequency is returned to the frequency that was selected prior to step 1.

Note: When storing the frequency in a Memory channel with the RIT function ON, the RIT offset frequency is added to or subtracted from the VFO frequency. The calculated data is then stored in the Memory channel.

AGC (AUTOMATIC GAIN CONTROL)

When using a mode other than FM, AGC selects the time constant for the Automatic Gain Control circuit.

Selecting a slow time constant will cause the receiver gain and S-meter readings to react slowly to large input changes. A fast time constant causes the receiver gain and the S-meter to react quickly to changes in the input signal. A fast AGC setting is particularly useful in the following situations:

- Tuning rapidly
- Receiving weak signals
- Receiving high-speed CW

For your convenience, the following default AGC time constant has already been programmed.

SSB/SSB-DATA: Slow (“AGC”) CW: Fast (“AGC -F”)

FSK: Fast (“AGC -F”) AM/AM-DATA: Slow (“AGC”)

■ AGC Time Constant Adjustment

You can pre-set up to 20 values (1 ~ 20) for the FAST/SLOW time constant (release time).

To change the default time constant:

1 Press **[AGC/T (SEL)]** to select FAST or SLOW.

- The AGC time constant icon appears on the display (“AGC”: Slow, “AGC -F”: Fast).

2 Press and hold **[AGC/T (SEL)]** to display the time constant pre-set value.

3 Turn the **MULTI/CH** control to set your desired time constant value.

4 If you want to turn the AGC OFF, press and hold **[CW T. (AGC OFF)]**.

- “AGC OFF” appears on the display.

Note: You cannot adjust the time constant in FM mode.

TRANSMISSION

VOX (VOICE-OPERATED TRANSMISSION)

VOX eliminates the necessity of manually switching to the transmission mode each time you want to transmit. The transceiver automatically switches to transmission mode when VOX senses that you have begun speaking into the microphone.

When using VOX, develop the habit of pausing between thoughts to allow the transceiver to drop back to reception mode briefly. You will then hear if anybody wants to interrupt, plus you will have a short period to gather your thoughts before speaking again. Your listeners will appreciate your consideration as well as respect your more articulate conversation.

Press **[VOX (LEV)]** to toggle between VOX ON and OFF.

- “VOX” appears when the VOX function is ON.



Microphone Input Level

To enjoy the VOX function, take the time to properly adjust the VOX gain. This level controls the capability of VOX to detect the presence or absence of your voice.

In CW mode, this level cannot be adjusted.

- 1 Select USB, LSB, FM, or AM mode.
- 2 Press **[VOX (LEV)]** to switch the VOX function ON.
 - “VOX” appears.



- 3 Press and hold **[VOX (LEV)]**.
 - The current VOX gain level appears on the sub-display.



- 4 While speaking into the microphone using your normal tone of voice, adjust the setting (default is 4) using the **MULTI/CH** control until the transceiver reliably switches to transmission mode each time you speak.
 - The selectable gain range is from 0 to 9.
 - The setting should not allow background noise to switch the transceiver to transmit mode.

Note: The VOX gain level can be adjusted even if VOX is switched OFF or while you are transmitting.

Delay Time

If the transceiver returns to reception mode too quickly after you stop speaking, your final word may not be transmitted. To avoid this, select an appropriate delay time that allows all of your words to be transmitted without an overly long delay after you stop speaking.

- 1 Select USB, LSB, FM, or AM mode.
- 2 Press **[VOX (LEV)]** to switch the VOX function ON.
 - “VOX” appears.
- 3 Press and hold **[KEY (DELAY)]**.
 - The current setting appears on the sub-display. The default is 50 (1500 ms).



- 4 While speaking into the microphone using your normal tone of voice, turn the **MULTI/CH** control such that the transceiver switches to reception mode after you have stopped talking.
 - The selectable range is from 5 to 100 (150 ms to 3000 ms) in steps of 5, or OFF.
- 5 Press **[CLR]** to store the parameter and exit the setting mode.

Anti-VOX Adjustment

The TS-590SG transceiver has a DSP IC to improve and customize incoming/ outgoing audio signals. When the VOX function is turned ON, the DSP IC adjusts the Anti-VOX level automatically, comparing the reception sound level and microphone input level. So, you never have to worry about adjusting the anti-VOX level.

Note: When connecting a headphone to the Phone jack, Anti-VOX will not function.

Data VOX

Although the microphone is normally used for VOX transmission, you can also utilize the audio input of the **ACC2** or **USB** connector. When the transceiver detects an audio signal on the **ACC2** or **USB** connector, it automatically transmits. You can select ACC2 or USB via Menu No. 69 (“Selecting a Data Transmission Line”) {page 61}.

- 1 Select USB, LSB, FM, or AM mode.
- 2 Press **[MENU]**, then press **[Q-M.IN]/ [Q-MR]** or turn the **MULTI/CH** control to select Menu No. 76.
- 3 Press **[M.IN]** to set the VOX with DATA input function ON.
- 4 If necessary, adjust the VOX gain level for the **ACC2** or **USB** connector {page 32}.

Note: While VOX with DATA input is set to ON (Menu No. 76), speaking into the microphone also activates the VOX function and you can still transmit using Mic **[PTT]**. Anti-VOX does not function with Data VOX.

While the Data VOX function remains ON and the transceiver is connected to a sound source, such as a PC, the transceiver may begin transmitting due to the sounds emitted from the sound source. To avoid unintended transmission while the transceiver is connected to the sound source, turn the Data VOX function OFF.

7 COMMUNICATING AIDS

■ Data VOX Delay Time

Select an appropriate delay time for after the audio signal input to the **ACC2** or **USB** connector ends.

- 1 Press **[MENU]**, then press **[Q-M.IN]/ [Q-MR]** or turn the **MULTI/CH** control to select Menu No. 77.
- 2 Press **[M.IN]/ [SCAN (SG.SEL)]** to set your desired delay time.
- 3 Press **[MENU]** to exit Menu mode.

■ USB/ ACC2 VOX Gain

When using the **ACC2** or **USB** connector for VOX transmission, take the time to properly adjust the VOX gain.

- 1 Press **[MENU]**, then press **[Q-M.IN]/ [Q-MR]** or turn the **MULTI/CH** control to select Menu No. 78 (USB connector) or Menu No. 79 (ACC2 connector).
- 2 While sending an audio signal to the **ACC2** or **USB** connector, adjust the value (default is 4) using **[M.IN]/ [SCAN (SG.SEL)]** until the transceiver reliably switches to transmit mode each time you send an audio signal to the connector.
- 3 Press **[MENU]** to exit Menu mode.

SPEECH PROCESSOR

The Speech Processor levels out large fluctuations in your voice while you speak. When using SSB, AM, or FM mode, this leveling action effectively raises the average TX power (SSB/AM) or raises the deviation to an adequate level (FM), resulting in a more understandable signal. The amount of voice compression is fully adjustable. Using the Speech Processor makes it easier to be heard by distant stations.

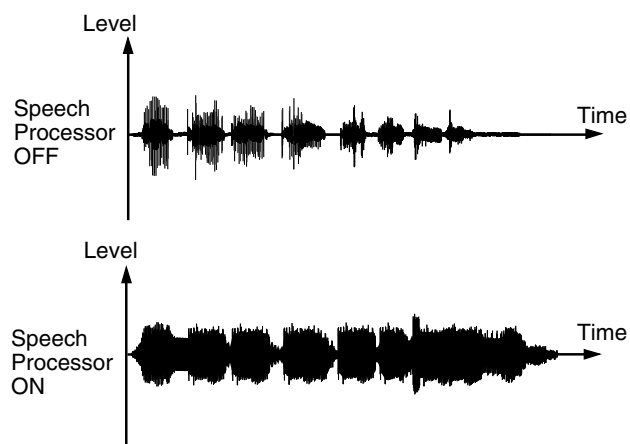

- 1 Select USB, LSB, AM, or FM mode.
- 2 Press **[PROC (LEV)]** to turn the Speech Processor ON.
 - “PROC” appears.
- 3 Press and hold **[PROC (LEV)]** to enter the Speech Processor input level adjustment mode.
- 4 As you speak into the microphone, turn the **MULTI/CH** control so that the compression meter indicates that the compression level is around 10 dB while you speak.

- Using higher compression will not improve your signal clarity or apparent signal strength. Excessively compressed signals are more difficult to understand due to distortion and are less pleasant to hear than signals with less compression.
- 5 Press and hold **[PROC (LEV)]** to exit the Speech Processor input level adjustment mode.
 - 6 Press **[MIC (CAR)]** to enter the Speech Processor output level adjustment mode.
 - As you speak into the microphone, turn the **MULTI/CH** control so that the ALC meter reflects according to your voice level, but does not exceed the ALC limit. Press **[MIC (CAR)]** to exit when you finish the adjustment.

Note: The Speech Processor ON/OFF are stored in each of the following modes.
SSB/ SSB-DATA/ CW/ FSK / FM/FM-DATA/ AM/ AM-DATA

■ Speech Processor Effect

When using the Speech Processor, you can change its effect.

- 1 Press **[MENU]**, then press **[Q-M.IN]/ [Q-MR]** or turn the **MULTI/CH** control to select Menu No. 35.
- 2 Press **[M.IN]/ [SCAN (SG.SEL)]** to set the Processor Effect to SOFT or HARD (default).
- 3 Press **[MENU]** to exit Menu mode.

XIT (TRANSMIT INCREMENTAL TUNING)

Similar to RIT, XIT provides the ability to change your transmission frequency by ± 9.99 kHz in steps of 10 Hz without changing your reception frequency. If the Fine Tuning function is ON, the frequency step size becomes 1 Hz (± 9.999 kHz).

- 1 Press **[XIT]**.
 - “XIT” and the XIT offset appear.



- 2 If required, press **[CL]** to reset the XIT offset to 0.
- 3 Turn the **RIT/ XIT** control to change your transmit frequency.



- 4 To turn XIT OFF, press **[XIT]**.
 - “XIT” and the offset frequency disappear. The transmission frequency is returned to the frequency that was selected prior to step 1.

Note:

- ◆ The frequency shift set by the XIT control is also used by the RIT function. Therefore, changing or clearing the XIT offset also affects the RIT offset.
- ◆ When the XIT frequency goes beyond the available transmission frequency, the transceiver automatically stops transmitting.

CUSTOMIZING TRANSMISSION SIGNAL CHARACTERISTICS

The quality of your transmission signal is important, regardless of which on-air activity you pursue. However, it is easy to be casual and overlook this fact since you don't listen to your own signal. The following sub-sections provide information that will help you tailor your transmission signal.

■ TX Filter Bandwidth (SSB/ AM)

Use Menu No. 31 to select one of the following TX low-cut filters: 10, 100, 200, 300 (default), 400, or 500 Hz.

Use Menu No. 32 to select one of the following TX high-cut filters: 2500, 2600, 2700 (default), 2800, 2900, or 3000 Hz.

■ TX Filter Bandwidth (SSB-DATA)

Use Menu No. 33 to select one of the following TX low-cut filters: 10, 100, 200, 300 (default), 400, or 500 Hz.

Use Menu No. 34 to select one of the following TX high-cut filters: 2500, 2600, 2700 (default), 2800, 2900, or 3000 Hz.

■ TX Equalizer (SSB/ SSB-DATA / FM/ FM-DATA/ AM/ AM-DATA)

Use Menu No. 36 to change the transmission frequency characteristics of your signal. You can select from 1 of 6 different transmission profiles including the default flat response. Selecting any of the following items from the Menu causes "EQ>" to appear on the display.

- **Off (oFF):**
The flat frequency response (default).
- **High boost 1 (Hb1)/ High boost 2 (Hb2):**
Emphasizes higher audio frequencies; effective for a bass voice. High boost 2 does not reduce the low frequency as much as High boost 1.
- **Formant pass (FP):**
Improves clarity by suppressing audio frequencies outside the normal voice frequency range.
- **Bass boost 1 (bb1)/ Bass boost 2 (bb2):**
Emphasizes lower audio frequencies; effective for a voice with more high frequency components. Bass boost 2 emphasizes more low frequency response.
- **Conventional (c):**
Emphasizes by 3 dB frequencies at 600 Hz and higher.
- **User (U):**
Reserved for the optional ARCP software. Off (oFF) is programmed at the factory as a default.

Frequency Response Curves

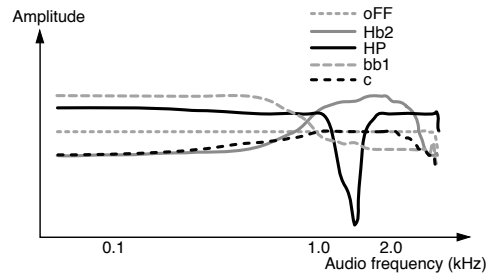

Note:

- ◆ When using the ARCP-590G, you can temporarily change each preset value.
- ◆ The TX Equalizer properties are stored in each of the following modes:
SSB/ SSB-DATA/ CW/ FSK / FM/FM-DATA/ AM/ AM-DATA

TRANSMIT INHIBIT

Transmit Inhibit prevents the transceiver from being placed in transmission mode. No signal can be transmitted when this function is ON, even if Mic [PTT] is pressed.

- **TX Inhibit OFF:** Transmission is allowed.
- **TX Inhibit ON:** Transmission is not allowed.

Switch this function ON or OFF via Menu No. 66. The default is OFF.

BUSY LOCKOUT

Busy Lockout prevents the transceiver from being placed in transmit mode if the current operating frequency is busy; in other words, if the squelch is open, you cannot transmit.

- **Busy Lockout OFF:** Transmission is allowed.
- **Busy Lockout ON:** Transmission is not allowed.

Switch this function ON or OFF via Menu No. 81. The default is OFF.

CHANGING FREQUENCY WHILE TRANSMITTING

Moving your frequency while transmitting is usually an unwise practice due to the risk of interfering with other stations. However, if necessary, by using the **Tuning** control you can change the operating frequency while transmitting. You also can change the XIT offset frequency while in transmission mode.

While transmitting, if you select a frequency outside the transmission frequency range, the transceiver is automatically forced to return to reception mode.

7 COMMUNICATING AIDS

CW BREAK-IN

Break-in allows you to transmit CW without manually switching between transmission and reception modes. Two types of Break-ins are available: Semi Break-in and Full Break-in.

Semi Break-in:

When the key contacts open, the transceiver automatically waits for the duration of the time period you selected. The transceiver then returns to reception mode.

Full Break-in:

As soon as the key contacts open, the transceiver returns to reception mode.

USING SEMI BREAK-IN OR FULL BREAK-IN

- 1 Press **[CW/FSK (REV)]** until you select CW mode.
 - “CW” appears.
- 2 Press **[VOX (LEV)]**.
 - “VOX” appears.
- 3 Press and hold **[KEY (DELAY)]**.
 - The current setting (FBK or delay time) appears. The default is 50 (500 ms).

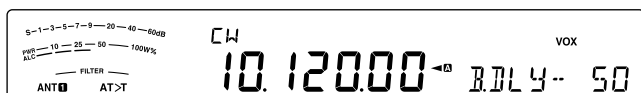

- 4 Turn the **MULTI/CH** control to select “FBK” (Full Break-in) or a delay time for Semi Break-in.
 - Delay time ranges from 5 to 100 (50 ms to 1000 ms) in steps of 5.



- 5 Begin sending.
 - The transceiver automatically switches to transmission mode.
 - **When FBK (Full Break-in) is selected:** The transceiver immediately switches to reception mode when the key opens.
 - **When a delay time is selected:** The transceiver switches to reception mode after the delay time that you have selected has passed.
- 6 Press **[CLR]** to exit.

Note: FBK (Full Break-in) cannot be used with the TL-922/922A linear amplifier.

ELECTRONIC KEYS

This transceiver has a built-in electronic keyer that can be used by connecting a keyer paddle to the transceiver's rear panel. Refer to “Keys for CW (PADDLE and KEY)” {page 2} for details regarding this connection. The built-in keyer supports lambic (squeeze) operation.

ELECTRONIC KEYS MODE

There are 2 modes of operation when using an electronic keyer for lambic keying operation. Mode A completes the current key sequence you are sending when you release the paddles. Mode B sends one more key, opposite the current key you are sending, upon releasing the paddles.

- 1 Press **[MENU]**, then press **[Q-M.IN]/ [Q-MR]** or turn the **MULTI/CH** control to select Menu No. 38.
- 2 Press **[M.IN]/ [SCAN (SG.SEL)]** to select “A” or “B” (default).
- 3 Press **[MENU]** to exit Menu mode.

CHANGING KEYS SPEED

The keying speed of the electronic keyer is fully adjustable. Selecting the appropriate speed is important in order to send error-free CW that other operators can copy solidly. Selecting a speed that is beyond your keying ability will only result in mistakes. You will obtain the best results by selecting a speed that is close to the speed used by the other station.

- 1 Press **[CW/FSK (REV)]** until you select CW mode.
 - “CW” appears.
- 2 Press **[KEY (DELAY)]**.
 - The current keying speed appears. The default is 20 (wpm).



- 3 While keying the paddle and listening to the TX (transmission) sidetone, turn the **MULTI/CH** control to select the appropriate speed.
 - The speeds range from 4 to 60 wpm, in steps of 1 wpm. The larger the number, the faster the speed.
- 4 Press **[KEY (DELAY)]** again to complete the setting.

Note: When using the semi-automatic “Bug” function, the selected speed applies only to the rate that dots are sent.

Invalid Break-In Operation

You can make break-in operation invalid while performing the keying speed adjustment.

To switch this function ON, access Menu No. 49, and select “on” (default is “oFF”).

- “VOX” blinks when break-in operation is enabled.

RISE TIME OF CW

The rise time of a CW signal is the time for the RF output to rise to its maximum power after the key is closed.

- 1 Press **[MENU]**, then press **[Q-M.IN]/ [Q-MR]** or turn the **MULTI/CH** control to select Menu No. 41.
- 2 Press **[M.IN]/ [SCAN (SG.SEL)]** to select "1", "2", "4", or "6" (default).
 - The default setting of 6 ms is fine for slow or medium keying speeds and normal weighting (dot/ dash ratio). 1, 2, or 4 ms are good for faster keying speeds.
- 3 Press **[MENU]** to exit Menu mode.

AUTO WEIGHTING

The electronic keyer can automatically change the dot/dash weighting. Weighting is the ratio of dash length to dot length. The weighting changes with your keying speed automatically, thus making your keying easier for other operators to copy (default).

Access Menu No. 42 to select "AUto" or "2.5" ~ "4.0" (in steps of 0.1) fixed weight ratio. The default is "auto". When a fixed weight ratio is selected, the dot/dash weight ratio is locked, irregardless of the keying speed.

■ Reverse Keying Weight Ratio

Auto Weighting increases the weighting as you increase your keying speed. However, the electronic keyer also can decrease the weighting as you increase your keying speed.

To switch this function ON, access Menu No. 43, and select "on". The default is OFF.

When setting Menu No. 42 to "Auto", refer to the following.

Reverse Keying Weight	Keying Speed (wpm)		
	4 ~ 24	25 ~ 44	45 ~ 60
OFF	1:2.8	1:3.0	1:3.2
ON	1:3.2	1:3.0	1:2.8

BUG KEY FUNCTION

The built-in electronic keyer can also be used as a semi-automatic key. Semi-automatic keys are also known as "Bugs". When this function is ON, dots are generated in the normal manner by the electronic keyer. Dashes, however, are manually generated by the operator by holding the keyer paddle closed for the appropriate length of time.

To switch this function ON, access Menu No. 44 and select "on". The default is OFF.

Note: When the Bug Key function is ON, CW Message Memory (see below) cannot be used.

CW MESSAGE MEMORY

This transceiver has 4 memory channels for storing CW messages. Each memory channel can store approximately 50 characters (equivalent of 250 dots). These memory channels are ideal for storing contest exchanges that you want to send repeatedly. Stored messages can be played back to check message content or for transmitting.

The electronic keyer has a function that allows you to interrupt playback and manually inject your own keying. To switch this function ON, access Menu No. 39 and select "on". The default is OFF.

The electronic keyer can also repeatedly play back the message that you stored. To switch this function ON, access Menu No. 62 and select "on". The default is OFF.

For repetitive message playback, you can change the interval between each series of messages. Use Menu No. 63 and select the time in the range of 0 to 60 seconds, in steps of 1 second.

Note:

- ◆ This function cannot be used when the Bug Key function is ON.
- ◆ Operating the keyer paddle while Menu No. 39 is OFF, cancels message playback. Even if message playback does not stop because of your keying start timing, you can cancel playback by pressing **[CLR]**.
- ◆ When the constant recording function of the optional VGS-1 is ON, you cannot use **[RX/4 (REC)]**.

■ Storing CW Messages

- 1 Press **[CW/FSK (REV)]** until you select CW mode.
 - "CW" appears.
- 2 Press and hold **[CH1 (REC)]**, **[CH2 (REC)]**, **[CH3 (REC)]**, or **[RX/4 (REC)]** to select a memory channel to be recorded.



- If Constant Recording is ON (Menu No. 61), you cannot store a message to **[RX/4 (REC)]** {page 63}. The default is ON.
- 3 Begin sending using the keyer paddle.
 - The message you send is stored in memory.



- 4 To complete the message storage, press **[CLR]** or **[CH1 (REC)]/ [CH2 (REC)]/ [CH3 (REC)]/ [RX/4 (REC)]** to stop.
 - When the number reaches 100(%), the memory becomes full and recording automatically stops.

Note: If you do not operate the keyer paddle after starting to record a message, a pause is stored in the channel.

7 COMMUNICATING AIDS

■ Checking CW Messages without Transmitting

- 1 Press **[CW/FSK (REV)]** until you select CW mode.
 - “CW” appears.
- 2 If Break-in is ON, press **[VOX (LEV)]** to turn VOX OFF.
- 3 Press **[CH1 (REC)]**, **[CH2 (REC)]**, **[CH3 (REC)]**, or **[RX/4 (REC)]** to select the channel to be played back.
 - The message is played back.
 - When Menu No. 62 is “oFF”, press and hold the current playback channel key to repeatedly play back the message saved to that key (a display such as “CP 1111” appears for the channel key you pressed.). To cancel the playback, press any channel key or **[CLR]**.
 - To play back the messages stored in the other channels in sequence, press the corresponding channel keys during playback. Up to 4 channels can be queued at the same time. (Repeat playback, by pressing and holding the keys, does not work during consecutive message playback.)



- While playing back the messages, you can also adjust the keyer speed by pressing **[KEY (DELAY)]** and turning the **MULTI/CH** control.
- To interrupt playback, press **[CLR]**.

■ Transmitting CW Messages

Messages can be transmitted using Semi Break-in/ Full Break-in or manual TX/ RX switching.

- 1 Press **[CW/FSK (REV)]** until you select CW mode.
 - “CW” appears.
- 2 To use Semi Break-in/ Full Break-in, press **[VOX (LEV)]**.
 - “VOX” appears.
 - If you are not using Semi Break-in/ Full Break-in, press **[SEND]**.
- 3 Press **[CH1 (REC)]**, **[CH2 (REC)]**, **[CH3 (REC)]**, or **[RX/4 (REC)]** select the channel to be played back.
 - The message is played back and transmitted automatically.
 - To transmit the messages stored in the other channels in sequence, press the corresponding channel keys during playback. Up to 4 channels can be queued at the same time.
 - While playing back the messages, you can also adjust the keyer speed by pressing **[KEY (DELAY)]** and turning the **MULTI/CH** control.
 - To cancel transmission, press **[CLR]**.

■ Erasing a CW Message

- 1 Press and hold **[CH1 (REC)]**, **[CH2 (REC)]**, **[CH3 (REC)]**, or **[RX/4 (REC)]** to select the message you want to erase.
 - “CP n –” appears, where “n” represents the channel number.
- 2 To erase the CW message, press **[CLR]** while continuing to hold the same key as in step 1 (**[CH1 (REC)]**, **[CH2 (REC)]**, **[CH3 (REC)]**, or **[RX/4 (REC)]**).
 - A beep sounds and the message is erased.

■ Changing the Inter-message Interval Time

For the message playback repeat, access Menu No. 62 and select “on”. You can also change the interval playback time of the message. Access Menu No. 63 and select the time in the range of 0 to 60 seconds, in steps of 1 second.

Note: Menu Nos. 56 and 57 settings are shared with the voice communication modes when the optional VGS-1 is installed.

■ Changing the CW Sidetone Volume

Turning the **AF** control does not change the CW sidetone playback volume. To change the CW sidetone volume, access Menu No. 06 and select “oFF”, or “1” to “20”. The default is “10”.

■ Insert Keying

If you operate a CW keyer manually while playing back a recorded CW message, the transceiver stops playing back the message. However, during contests or regular QSOs, you may sometimes want to insert a different number or message at a certain point in the recorded message.

In this case, first record the CW message as usual {page 35}, without the additional number or message you want to insert. Then, access Menu No. 39 and select “on”.

Now, if you operate a CW keyer while you play back a recorded message, the transceiver pauses the playback of the recorded message, instead of stopping it. When you finish sending the number or message with the keyer, the transceiver resumes playback of the message.

FREQUENCY CORRECTION FOR CW

If you operate both SSB and CW modes, you would sometimes use SSB mode (USB or LSB) just to watch and listen to CW signals. It is fine just to monitor those CW signals but you have experienced that changing the mode from SSB to CW results in losing the target CW signal. This is because the frequency on the display always shows the true carrier frequency for all modes. If you want the transceiver to shift the reception frequency to trace the receiving CW signal when changing the mode from SSB (USB or LSB) to CW, switch this function ON. The transceiver shifts the reception frequency when changing the mode from SSB to CW, so you can still hear the target signal and instantly transmit the signal in CW without adjusting the frequency.

- 1 Press **[MENU]**, then press **[Q-M.IN]/ [Q-MR]** or turn the **MULTI/CH** control to select Menu No. 48.
- 2 Press **[M.IN]** to select “on”.
- 3 Press **[MENU]** to exit Menu mode.

AUTO CW TX IN SSB MODE

If you operate both SSB and CW modes, you can configure the transceiver to change the operating mode from SSB (USB or LSB) to CW and then transmit in CW mode automatically when you operate the CW keyers.

The mode automatically changes from USB to CW and LSB to CWR, regardless of the setting for Menu No. 42 (Frequency correction for changing SSB to CW). Therefore, when the CW signal is received in SSB mode, you can operate the paddle or keyer to immediately communicate CW with another station.

- 1 Press **[MENU]**, then press **[Q-M.IN]/ [Q-MR]** or turn the **MULTI/CH** control to access Menu No. 47.
- 2 Press **[M.IN]** to select “on”.
- 3 Press **[MENU]** to exit Menu mode.

Note: You must switch the CW Break-in function ON to change the mode and transmit in CW mode {page 34}.

MIC UP/ DWN KEY PADDLE MODE

This function allows you to send CW messages without using an optional paddle {page 2}. The Mic **[UP]** key can be used as the dot paddle and the Mic **[DWN]** key can be used as the dash paddle.

To activate Mic UP/ DWN key Paddle mode:

- 1 Press **[MENU]**, then press **[Q-M.IN]/ [Q-MR]** or turn the **MULTI/CH** control to access Menu No. 46.
- 2 Press **[M.IN]** to select “PA”.
- 3 Press **[MENU]** to exit Menu mode.
 - Press and hold Mic **[DWN]** to send dots or Mic **[UP]** to send dashes in CW mode.
- 4 To exit Mic UP/ DWN key Paddle mode, access Menu No. 46 and select “PF”.

SWAP DOT AND DASH PADDLE POSITIONS

This function reverses the position of the dot and dash paddle positions. As a default, the left paddle sends dots and the right paddle sends dashes. When this function is ON, the left paddle will send dashes and the right paddle will send dots.

- 1 Press **[MENU]**, then press **[Q-M.IN]/ [Q-MR]** or turn the **MULTI/CH** control to access Menu No. 45.
- 2 Press **[M.IN]** to select “on”.
- 3 Press **[MENU]** to exit Menu mode.
 - The left paddle now sends dashes and the right paddle now sends dots. To return to the normal paddle positions, access Menu No. 45 and select “oFF”.

7 COMMUNICATING AIDS

MORSE CODE DECODER

The decoded character strings are displayed on the sub-display (up to 8 characters) by decoding the received Morse code.

- 1 Press **[CW/FSK (REV)]** until you select CW mode.
 - “CW” appears.
- 2 Press **[DATA]** to toggle the Morse Code Decoder ON and OFF.
 - “DATA” appears when the Morse Code Decoder is ON.
 - Whenever one character is decoded, the character is displayed from the right end in Sub-display.



THRESHOLD LEVEL ADJUSTMENT

Adjust the threshold level in order to reduce the influence of the signal strength and external noise, adjust the threshold level.

- 1 With the Morse code decoder ON, press and hold **[DATA]**.
 - Threshold Level Setting mode starts. “DATA” will blink and the current number display and meter display levels will blink.
- 2 Turn the **MULTI/CH** control to set the threshold level.
 - Adjust the threshold from 1 to 10 for weak signals in which the S-meter does not show any deflection.
 - Adjust the threshold from 11 to 30 for strong signals in which the S-meter deflects the needle.



- 3 Press **[DATA (REV)]** or **[CLR]** to exit the threshold level adjustment mode.

Note:

- ◆ The keying speeds range from 4 to 60 wpm.
- ◆ The weighting ranges from 2.5 (1:2.5) to 4.0 (1:4.0).
- ◆ There are eight corresponding abbreviations: \overline{BT} , \overline{AR} , \overline{AS} , \overline{HH} , \overline{SK} , \overline{KN} , \overline{BK} , and \overline{SN} .
- ◆ The split-frequency and RIT/XIT frequency are not displayed during this function.
- ◆ The setting mode is displayed by priority in setting modes. When the setting modes are finished, the most recent decoded character strings are displayed.
- ◆ Depending on radio wave conditions (noise, fading, signal interference, etc.), decoding may not be performed correctly.
- ◆ If the keying speed of the target signal changes during reception, the character immediately before and after the changed speed will not be decoded correctly.
- ◆ Characters that cannot be decoded are displayed as underscores.
- ◆ Available alphanumeric characters that can be displayed are listed below.
0 1 2 3 4 5 6 7 8 9 A B C D E F G H I J K L M N O P Q R S T
U V W X Y Z / @ ?.
- ◆ The number 0 is displayed by entering a slash.
- ◆ This function does not work with message playback that is recorded.

8 DATA COMMUNICATIONS

RADIO TELETYPE (RTTY)

RTTY is the data communications mode with the longest history. It was originally designed for use with mechanical teletypewriters which were often used before personal computers became common. Now you can easily start operating RTTY with a personal computer and MCP. Unlike Packet, each time you type a letter, it is transmitted over the air. What you type is transmitted and displayed on the computer screen of the recipient.

RTTY operation uses frequency shift keying (FSK) and the 5-bit Baudot code or the 7-bit ASCII code to transmit information.

For cable connections, refer to “CONNECTING TO RTTY EQUIPMENT (FSK)” {page 72}.

For further information, consult reference books about Amateur Radio.

- 1 Access Menu No. 50 and select an FSK shift.
 - FSK shift is the difference in frequencies between a mark and a space.
 - The 170 Hz shift (default) is normally used on the Amateur bands for the RTTY.
- 2 Access Menu No. 51 and select a key-down polarity.
 - Select “oFF” (default) to transmit a mark when keying down or “on” to transmit a space.
- 3 Access Menu No. 52 and select “2125” (high tone) or “1275” (low tone) for mark.
 - High tone (default) is commonly used nowadays.
- 4 Select an operating frequency.
- 5 Press **[CW/FSK (REV)]** to select FSK mode.
 - “FSK” appears.



- If necessary, access Menu No. 74 to configure the appropriate audio output level for your MCP. The audio output level of ANO (**ACC2** connector/ pin 3) changes {page 69}. The **AF** control cannot be used to adjust the audio level for your MCP.
- 6 Some stations may be operating in Reverse shift. In this case, press and hold **[CW/FSK (REV)]** to reverse the shift (the upper sideband is used).
 - “FSR” appears.



- Traditionally, the lower sideband is used for FSK operation. Press and hold **[CW/FSK (REV)]** again to return to the lower sideband. “FSK” appears.

Note: When changing FSK/ FSK-R, the receiving polarity is reversed (a mark signal and a space signal interchange). Transmitting polarity is not reversed.

- 7 You can switch to transmit mode by entering a command from the computer to the RTTY device.
 - The TX-RX LED changes from green (RX) to red (TX).
- 8 Begin sending data from your computer.
 - Press and hold **[PWR (TX MONI)]** to monitor your signals. Press and hold **[PWR (TX MONI)]** again to quit this function.
- 9 When finished transmitting, enter a command from your computer to return to reception mode.
 - The TX-RX LED changes from red (TX) to green (RX).

The following frequencies (measured in kHz) are commonly used for RTTY operation:

U.S.A./ Canada	IARU Region 1 (Europe/ Africa)
1800 ~ 1840	1838 ~ 1842
3605 ~ 3645 (DX: 3590)	3580 ~ 3620
7080 ~ 7100 (DX: 7040)	7035 ~ 7045
10140 ~ 10150	10140 ~ 10150
14070 ~ 14099.5	14080 ~ 14099.5
18100 ~ 18110	18101 ~ 18109
21070 ~ 21100	21080 ~ 21120
24920 ~ 24930	22920 ~ 24929
28070 ~ 28150	28050 ~ 28150

PHASE-SHIFT KEYING 31 BAUD (PSK31)

PSK31 is a digital modulation method used in amateur radio communications. You can perform data communications in real-time using a keyboard, like RTTY. Additionally, because of the narrow bandwidth (31.25 Hz) you can even use PSK31 on congested frequencies. Another merit to PSK31 is that it can be enjoyed with a simple antenna and low transmit power.

Using the sound function of your PC along with PSK31 software, many amateur radio operators enjoy PSK31.

- Refer to “CONNECTING TO DATA COMMUNICATION EQUIPMENT” {page 71} for connections.
- When managing PSK31 using the sound capability of a PC, use SSB mode.
- Set AGC to fast.
- Turn off the speech processor.
- Refer to “EXTERNAL AUDIO SETTINGS” {page 61} for Audio Settings.

For further information, consult reference books about Amateur Radio.

9 REJECTING INTERFERENCE

DSP FILTERS

KENWOOD digital signal processing (DSP) technology is adapted to this transceiver. Using DSP filtering (AF), you can control the bandwidth, cancel the multiple jamming beat, and reduce the noise level.

CHANGING THE DSP FILTER BANDWIDTH

For improving interference reduction capability, this transceiver also provides IF filters designed using DSP technology. To change the passband of the filter, you can use the method of changing the high and low cut-off frequency (HI/LOW cut), or you can use the method of changing the bandwidth and center frequency (WIDTH/SHIFT). Changing the IF filter does not affect the current receive frequency.

- The meter display changes, based on the bandwidth you are setting up.

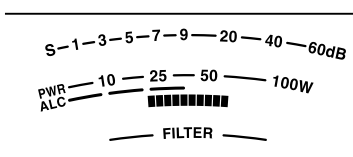

SSB/ FM/ AM Mode (High cut/Low cut)

- Select SSB, FM, or AM mode.
- Turn the **LO/WIDTH** control clockwise to raise the low cut-off frequency, or counterclockwise to lower the low cut-off frequency.

Mode	Low cut Frequency (Hz)	Default
SSB/ FM	0, 50, 100, 200, 300, 400, 500, 600, 700, 800, 900, 1000	300 Hz
AM	0, 100, 200, 300	100 Hz

Turn the **HI/SHIFT** control clockwise to raise the high cut-off frequency, or counterclockwise to lower the high cut-off frequency.

Mode	High cut Frequency (Hz)	Default
SSB/ FM	1000, 1200, 1400, 1600, 1800, 2000, 2200, 2400, 2600, 2800, 3000, 3400, 4000, 5000	2600 Hz
AM	2500, 3000, 4000, 5000	5000 Hz

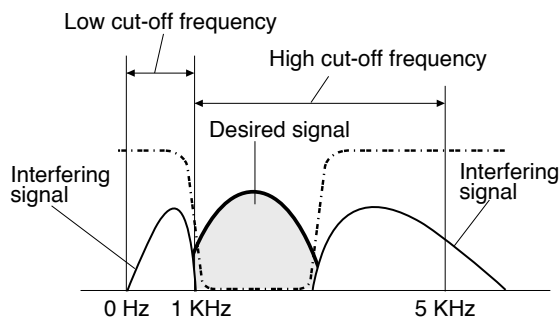

Note: The cut-off frequencies can be adjusted independently for each operating mode. When you change the operating mode, the previous setting is recalled for each operating mode.

CW/ FSK Mode (Width/Shift)

- Select CW or FSK mode.
- Turn the **LO/WIDTH** control clockwise to increase the bandwidth (wide), or counterclockwise to decrease the bandwidth (narrow).

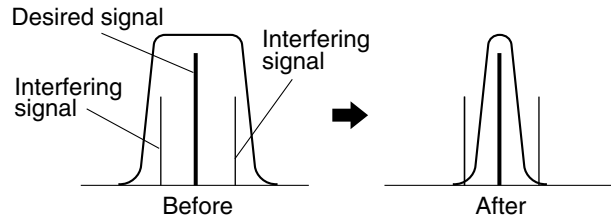

Mode	Bandwidth Selection (Hz)	Default
CW	50, 80, 100, 150, 200, 250, 300, 400, 500, 600, 1000, 1500, 2000, 2500	500 Hz
FSK	250, 500, 1000, 1500	500 Hz

- As for CW, you can further adjust the shift frequency for the pass band. Turn the **HI/SHIFT** control clockwise to increase the shift frequency (high), or counterclockwise to decrease the shift frequency (low).

Shift Frequency (Hz)	Default
300, 350, 400, 450, 500, 550, 600, 650, 700, 750, 800, 850, 900, 950, 1000	800 Hz

SSB Data Mode (Width/Shift)

- Select Data mode (USB-DATA/LSB-DATA).
- Turn the **LO/WIDTH** control clockwise to increase the bandwidth (wide), or counterclockwise to decrease the bandwidth (narrow).

Bandwidth Selection (Hz)	Default
50, 80, 100, 150, 200, 250, 300, 400, 500, 600, 1000, 1500, 2000, 2500	2500 Hz

- Turn the **HI/SHIFT** control clockwise to increase the shift frequency (high), or counterclockwise to decrease the shift frequency (low).

Shift Frequency (Hz)	Default
1000, 1100, 1200, 1300, 1400, 1500, 1600, 1700, 1750, 1800, 1900, 2000, 2100, 2210	1500 Hz

IF Filter A and B

This transceiver has 2 built-in IF filters: A and B. The IF Filter settings are stored with the last settings of the **LO/WIDTH** and **HI/SHIFT** controls.

Press [IF FIL] to toggle between IF Filter setting A and B (each VFO A and VFO B).

- “**A**” appears when IF filter setting A is selected and “**B**” appears when IF filter setting B is selected.

Press and hold **[IF FIL]** to momentarily display each setting value of the DSP filter band as follows:

SSB/ SSB-DATA, AM/ FM mode:
High cut Frequency > Low cut Frequency
CW/ SSB/ SSB-DATA mode:
Shift Frequency > Bandwidth
FSK mode: Bandwidth only

■ Filter control in SSB/ SSB-DATA mode (High/Low and Width/Shift)

In SSB and SSB-DATA modes, you can switch the Hi/Low cut operation and the Width/Shift operation.

- 1 Press **[MENU]**, then press **[Q-M.IN]/ [Q-MR]** or turn the **MULTI/CH** control to select Menu No. 28 (SSB) or 29 (SSB-DATA).
- 2 Press **[M.IN]/ [SCAN (SG.SEL)]** to select the filter control type HI/LO (1) or WIDTH/SHIFT (2).

AUTO NOTCH FILTER (SSB)

The Auto Notch filter automatically locates and attenuates any single interfering tone within the receive pass band. This function operates digitally at the IF filter level, hence it can affect your S-meter reading and may also affect (slightly attenuate) your desired signal. However, controlling the AGC level by notching out the strong interfering beat signals could bring up the desired SSB signal that is covered by the interfering beat signal. If the interfering tone is weak, you may find that Beat Cancel eliminates them more effectively.

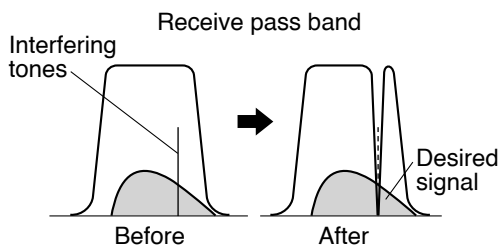

Press and hold **[BC (A.NOTCH)]** to toggle the Auto Notch Filter ON and OFF.

- “A.NOTCH” appears when this function is ON.
- The interfering beat signals are notched out.

■ Auto Notch Tracking Speed

If the interfering beat signals change the tone frequency randomly, you can adjust the Auto Notch tracking speed.

- 1 Press **[MENU]**, then press **[Q-M.IN]/ [Q-MR]** or turn the **MULTI/CH** control to select Menu No. 30.
- 2 Press **[M.IN]/ [SCAN (SG.SEL)]** to select the level from FIX (0), and 1 to 4.
 - Level 1 is the slowest beat tone tracking speed and Level 4 is the fastest. FIX terminates the beat tone tracking. Adjust this parameter manually to remove the beat signal if necessary.
- 3 Press **[MENU]** to exit Menu mode.

MANUAL NOTCH FILTER (SSB/ CW/ FSK)

Use manual notch when you want to vary the width of the notch while verifying the interfering signal.

- 1 Press **[NOTCH (WIDE)]** to toggle the Manual Notch Filter ON and OFF.
 - “NOTCH” appears when this function is ON.
- 2 Turn the **NOTCH** control to adjust to the point where beat noise just disappears.

■ Notch Filter Bandwidth

Press and hold **[NOTCH (WIDE)]** to toggle the Notch filter bandwidth between NORMAL and WIDE.

- “NOTCH W” appears when the Notch filter bandwidth is set to WIDE.

BEAT CANCEL (SSB/ AM)

Two types of Beat Cancel DSP filters are available. Beat Cancel 1 (BC1) is effective for removing a weak beat or continuous beat signals. Beat Cancel 2 (BC2) is effective for removing intermittent beat signals, such as CW signals.

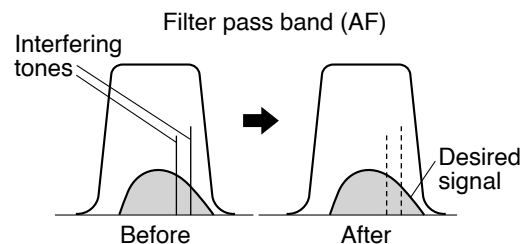

Press **[BC (A.NOTCH)]** to cycle through Beat Cancel 1, Beat Cancel 2, and OFF.

- “BC 1” or “BC 2” appears when the Beat Cancel function is ON.
- The interfering beat signals are removed.

NOISE REDUCTION (ALL MODES)

This transceiver provides 2 types of Noise Reduction functions (NR1 and NR2) for reducing random noise which interferes with the desired signal.

NR1 differs, depending on the reception mode. When receiving a voice call in SSB/ FM/ AM mode, noise reduction uses a spectrum subtraction system. When receiving a non-voice call in CW/ FSK mode, noise reduction uses a LMS adaptive filter which emphasizes the periodic signal.

NR2 uses a SPAC format, which extracts a periodic signal from within the received signal.

Press **[NR (LEV)]** to cycle between NR1, NR2, and OFF.

- “NR 1” or “NR 2” appears, depending on which noise reduction filter is selected.

9 REJECTING INTERFERENCE

■ Setting the NR1 Level Adjustment

NR1 uses an adaptive filter to reduce the noise element from the received signals. When the S/N ratio is reasonably good in SSB, using NR1 will improve the S/N further.

While NR1 is ON, you can further adjust the noise reduction level by pressing and holding **[NR (LEV)]**, then turning the **MULTI/CH** control to select the level from 1 to 10. The default is 5. The level is saved separately for SSB/FM/AM and CW/FSK.

■ Setting the NR2 Time Constant

You can change the correlation time for NR2 (SPAC). When in SSB mode, select the correlation time that allows you to hear signals with clarity. When receiving CW, it is best to select the longest correlation time that allows reliable reception. The longer the correlation time, the better the S/N ratio.

When NR2 is ON, press and hold **[NR (LEV)]**, then turn the **MULTI/CH** control to select the correlation time from 2 to 20 ms. The default is 20 ms.

Note:

- ◆ When using Noise Reduction 1 in SSB, FM, or AM mode, the beat signal is suppressed along with the normal signal. This is not a malfunction.
- ◆ Using Noise Reduction 2 in SSB mode may lower the clarity of signals or induce pulse noise, depending on the conditions.

NOISE BLANKER

The Noise Blanker is designed to reduce pulse noise such as that generated by automobile ignitions. The Noise Blanker does not function in FM mode.

- NB1 performs blanking through an analog circuit. NB2 performs blanking using DSP.

Press **[NB (LEV)]** to cycle between Noise Blanker 1, Noise Blanker 2, and OFF.

- “**NB1**” or “**NB 2**” appears, depending on which Noise Blanker is selected.

You can further adjust the Noise Blanker level from 1 to 10. The default level is 6. Press and hold **[NB (LEV)]**, then turn the **MULTI/CH** control to adjust the Noise Blanker level.

- “NB LV.” and the current level appear on the sub-display.

Note:

- ◆ The Noise Blanker is available only for SSB, CW, FSK, and AM modes.
- ◆ Increasing the Noise Blanker level degrades the intermodulation characteristics of the transceiver.
- ◆ For effective Noise Blanker operation, experiment with both NB1 and NB2 on each band.
- ◆ When using Noise Blanker 2 and a CW signal is received, there are times when the received signal may be distorted. This is not a malfunction.
- ◆ While operating the Noise Blanker 2, if a strong signal is received, the Blanking effect will decrease. In theory, this is how the operation should perform; it is not a malfunction.

PRE-AMPLIFIER

Switching the pre-amplifier OFF may help reduce interference from adjacent frequencies.

Press **[PRE (ANT 1/2)]** to toggle the pre-amplifier ON and OFF.

- “PRE” appears when this function is ON.

The ON/ OFF setting will be automatically stored in the current band. Each time you select the same band, the same setting will be automatically selected. The frequency range of each band is provided in the table below (under “ATTENUATOR”).

ATTENUATOR

The Attenuator reduces the level of received signals. This function is useful when there is strong interference from adjacent frequencies.

Press **[ATT (RX ANT)]** to toggle the attenuator ON and OFF.

- “ATT” appears when this function is ON.

The ON/ OFF setting will be automatically stored in the current band. Each time you select the same frequency band, the attenuator setting will be automatically recalled. The frequency range of each band is shown below.

Frequency Band (MHz)	Pre-amplifier (Default)	Attenuator (Default)
0.03 ~ 0.522	OFF	OFF
0.522 ~ 2.5	OFF	OFF
2.5 ~ 4.1	OFF	OFF
4.1 ~ 6.9	OFF	OFF
6.9 ~ 7.5	OFF	OFF
7.5 ~ 10.5	ON	OFF
10.5 ~ 14.5	ON	OFF
14.5 ~ 18.5	ON	OFF
18.5 ~ 21.5	ON	OFF
21.5 ~ 25.5	ON	OFF
25.5 ~ 30.0	ON	OFF
30.0 ~ 60.0	ON	OFF

CW REVERSE (RECEPTION)

This function pivots the BFO from the default position (USB) to another position (LSB) in CW mode. It is sometimes effective to remove the interfering signals from the IF passband by pivoting the BFO.

1 Press **[CW/FSK (REV)]** until “CW” appears.

2 Press and hold **[CW/FSK (REV)]**.

- “CW” changes to “CWR”.

3 To recover the default BFO position, press and hold **[CW/FSK (REV)]** again.

- “CWR” changes to “CW”.

10 MEMORY FEATURES

MEMORY CHANNELS

This transceiver provides you with 120 memory channels, numbered 00 to 99, P0 to P9, and E0 to E9, for storing operating frequency data, modes, and other information. Memory channels 00 to 99 are called Conventional Memory Channels. Memory channels P0 to P9 are designed for programming VFO tuning ranges and scan ranges. Memory channels E0 to E9 are Expansion Memory Channels. The data you can store is listed below.

Conventional memory channels are used for storing data you will often recall. For example, you may store the frequency where you regularly meet your club members.

Parameter	Channel 00 ~ 99/ E0 ~ E9	Channel P0 ~ P9
RX Frequency	Yes	Yes ¹
TX Frequency	Yes	(simplex)
Mode for RX	Yes	Yes ¹
Mode for TX	Yes	(simplex)
Programmable VFO Start/ End Frequencies	No	Yes
Tone Frequency	Yes	Yes
CTCSS Frequency	Yes	Yes
Tone/ CTCSS ON/ OFF Status	Yes	Yes
Memory Name	Yes	Yes
Memory Channel Lockout ON/ OFF	Yes ¹	Yes ¹
Filter A/ B status	Yes	Yes

¹ Changing the data after recalling a memory channel overwrites the contents of the channel.

The default values for the Expansion Memory Channels are listed below. (All channels, Simplex, USB mode, and Memory Names are blank.)

No.	K type	E type
E0	5332 kHz	5260 kHz
E1	5348 kHz	5280 kHz
E2	5358.5 kHz	5290 kHz
E3	5373 kHz	5368 kHz
E4	5405 kHz	5373 kHz
E5	Blank	5400 kHz
E6	Blank	5405 kHz
E7	Blank	Blank
E8	Blank	Blank
E9	Blank	Blank

STORING DATA IN MEMORY

There are 2 methods used for storing transmission/reception frequencies and associated data in memory channels 00 to 99. Use either method, depending on the relationship of the reception and transmission frequencies you store:

- Simplex channels:
RX frequency = TX frequency
- Split-frequency channels:
RX frequency ≠ TX frequency

Memory channels P0 to P9 can also be used as simplex channels.

Note: When RIT or XIT is ON, the frequency that includes the RIT or XIT offset will be stored.

■ Simplex Channels

- 1 Press **[A/B (A=B)]** to select VFO A or VFO B.
 - “◀A” or “◀B” appears to show which VFO is selected.
- 2 Select the frequency, mode, etc., to be stored.
- 3 Press **[M.IN]** to enter Memory Scroll mode.
 - “M.SCR” appears.



- To exit Memory Scroll mode and abort the storage process, press **[CLR]**.
- 4 Turn the **MULTI/CH** control, or press Mic **[UP]/[DWN]** to select a memory channel.
 - You can also select a channel by entering a 2-digit number, such as 12, using the numeric keys. Press **[1.8 (1)]**, **[3.5 (2)]** for example.

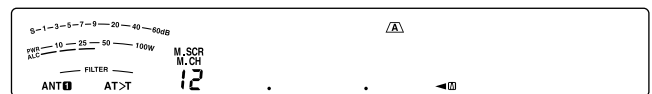

- 5 Press **[M.IN]** again to store the data.
 - The previous data stored in the channel is overwritten.

■ Split-Frequency Channels

- 1 Press **[A/B (A=B)]** to select VFO A or VFO B.
 - “◀A” or “◀B” appears to show which VFO is selected.
- 2 Select the frequency, mode, etc., to be stored.
 - This frequency and mode will be used for transmitting.
- 3 Press **[A/B (A=B)]** to select the other VFO.
- 4 Select the reception frequency and mode.
- 5 Press **[SPLIT]**.
 - “SPLIT” appears.



- 6 Press **[M.IN]** to enter Memory Scroll mode.

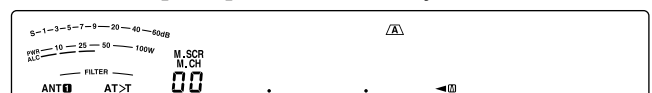

- To exit Memory Scroll mode and abort the storage process, press **[CLR]**.
- 7 Turn the **MULTI/CH** control, or press Mic **[UP]/[DWN]** to select a memory channel.

10 MEMORY FEATURES

- You can also select a channel by entering a 2-digit number, such as 12, using the numeric keys. Press **[1.8 (1)]**, **[3.5 (2)]** for example.

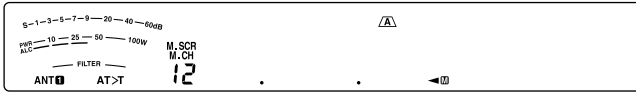

8 Press **[M.IN]** to store the data.

- The previous data stored in the channel is overwritten.

Note: When subtone frequencies differ between TX and RX while performing memory-VFO split operation, the subtone frequency for TX will be stored in the memory channel.

MEMORY RECALL AND SCROLL

There are 2 modes which allow you to retrieve frequencies and associated data that you stored in a memory channel: Memory Recall and Memory Scroll.

■ Memory Recall

In this mode, the transceiver receives and transmits using a frequency that you retrieve. You can temporarily change the frequency and associated data without overwriting the contents of the memory channel when Menu No. 22 is ON (default is OFF).

1 Press **[M/V]** to enter Memory Recall mode.

- The memory channel that was last selected appears.



2 Turn the **MULTI/CH** control, or press Mic **[UP]/[DWN]** to select a memory channel.

- Continuously holding down Mic **[UP]/[DWN]** steps the transceiver through the memory channels until the key is released.
- Memory channels which contain no data are skipped.
- You cannot change memory channels while transmitting.

3 To exit Memory Recall mode, press **[M/V]**.

Note: If Menu No. 22 is set to "on", the frequency of the memory channel can be changed.

■ Memory Scroll

Use this mode to check the contents of the memory channels without changing the current reception frequency. In this mode, frequencies you retrieve are not used for receiving and transmitting.

1 Press **[M.IN]** to enter Memory Scroll mode.

- The memory channel that was last selected appears.



2 Turn the **MULTI/CH** control, or press Mic **[UP]/[DWN]** to step through the memory channels.

- You can also change channels by entering a 2-digit number. Press **[24 (8)]**, **[28 (9)]** for example.

3 To exit Memory Scroll mode, press **[CLR]**.

- The transceiver re-displays the memory channel or VFO frequency that was selected before you activated Memory Scroll.

Note: Do not press **[M.IN]** again after entering Memory Scroll mode. Pressing **[M.IN]** results in over-writing the current VFO data to the memory channel you selected.

■ Temporary Frequency Changes

After retrieving frequencies and associated data in Memory Recall mode, you can temporarily change the data without overwriting the contents of the memory channel.

1 Access Menu No. 22 and select "on".

- Skip this step when changing only the associated data (not the frequency).

2 Recall a memory channel.

3 Change the frequencies and associated data.

- Use only the **Tuning** control to select a frequency.

4 If necessary, for future use, store the changed data in another memory channel. Refer to "Channel → Channel Transfer" {below}.

Note:

- If Menu No. 22 is set to "on", the frequency of the memory channel can be change
- When turning this function ON, you can use the following functions in Memory Channel mode.
 - Auto Zero-Beat
 - Shiftable RX Frequency during Split Transmission

MEMORY TRANSFER

■ Memory → VFO Transfer

After retrieving frequencies and associated data from Memory Recall mode, you can copy the data to the VFO. This function is useful, for example, when the frequency you want to monitor is near the frequency stored in a memory channel.

1 Recall the desired memory channel.

2 Press **[M>V]**.

- When a simplex channel is recalled, the data is copied to VFO A or VFO B, depending on which VFO was used to recall the channel.
- When a split channel is recalled, the RX data is copied to VFO A and the TX data is copied to VFO B.

Note: Pressing **[M>V]** after temporarily changing the retrieved data copies the new data to the VFO.

■ Channel → Channel Transfer

You can also copy channel information from one memory channel to another. This function is useful when storing frequencies and associated data that you temporarily change in Memory Recall mode.

- 1 Recall the desired memory channel.
- 2 Press **[M.IN]** to enter Memory Scroll mode.
 - To exit Memory Scroll mode, press **[CLR]**.
- 3 Select the memory channel where you would like the data copied, using the **MULTI/CH** control.
- 4 Press **[M.IN]**.

Channel 00 ~ 99 Channel E0 ~ E9	➔	Channel 00 ~ 99 Channel E0 ~ E9
RX frequency	➔	RX frequency
TX frequency	➔	TX frequency
Mode for RX	➔	Mode for RX
Mode for TX	➔	Mode for TX
Tone frequency	➔	Tone frequency
CTCSS frequency	➔	CTCSS frequency
Tone/ CTCSS ON/ OFF status	➔	Tone/ CTCSS ON/ OFF status
Memory Name	➔	Memory Name
Memory Channel Lockout ON/ OFF	➔	Memory Channel Lockout OFF
Filter A/ B status	➔	Filter A/ B status

Channel 00 ~ 99 Channel E0 ~ E9	➔	Channel P0 ~ P9
RX frequency	➔	TX/RX frequency
	➔	Start frequency
	➔	End frequency
Mode for RX	➔	Mode for TX/RX
TX frequency	➔	—
Mode for TX	➔	—
Tone frequency	➔	Tone frequency
CTCSS frequency	➔	CTCSS frequency
Tone/ CTCSS/ Cross tone ON/ OFF status	➔	Tone/ CTCSS/ Cross tone ON/ OFF status
Memory Name	➔	Memory Name
Memory Channel Lockout ON/ OFF	➔	Memory Channel Lockout OFF
Filter A/ B status	➔	Filter A/ B status

Channel P0 ~ P9	➔	Channel 00 ~ 99
TX/RX frequency	➔	RX frequency
	➔	TX frequency
Mode for TX/RX	➔	Mode for RX
	➔	Mode for TX
Start frequency	➔	—
End frequency	➔	—
Tone frequency	➔	Tone frequency
CTCSS frequency	➔	CTCSS frequency
Tone/ CTCSS/ Cross tone ON/ OFF status	➔	Tone/ CTCSS/ Cross tone ON/ OFF status

Channel P0 ~ P9	➔	Channel 00 ~ 99
Memory Name	➔	Memory Name
Memory Channel Lockout ON/ OFF	➔	Memory Channel Lockout OFF
Filter A/ B status	➔	Filter A/ B status

Channel P0 ~ P9	➔	Channel P0 ~ P9
TX/RX frequency	➔	TX/RX frequency
Start frequency	➔	Start frequency
End frequency	➔	End frequency
Mode for TX/RX	➔	Mode for TX/RX
Tone frequency	➔	Tone frequency
CTCSS frequency	➔	CTCSS frequency
Tone/ CTCSS/ Cross tone ON/ OFF status	➔	Tone/ CTCSS/ Cross tone ON/ OFF status
Memory Name	➔	Memory Name
Memory Channel Lockout ON/ OFF	➔	Memory Channel Lockout OFF
Filter A/ B status	➔	Filter A/ B status

Note: After copying, the Memory Channel Lockout turns OFF.

STORING FREQUENCY RANGES

Memory channels P0 to P9 allow you to store frequency ranges for VFO tuning and Program Scan. Program Scan is described in the next chapter. To tune or scan frequencies within a specified range, store the start and end frequencies for that range in advance.

- 1 Press **[A/B (A=B)]** to select VFO A or VFO B.
- 2 Select the desired start frequency.
- 3 Press **[M.IN]** to enter Memory Scroll mode.
 - To exit Memory Scroll mode and abort the storage process, press **[CLR]**.
- 4 Turn the **MULTI/CH** control, or press Mic **[UP]/ [DOWN]** to select a memory channel in the range of P0 to P9.

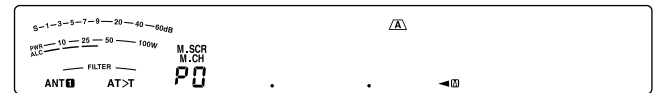

- 5 Press **[M.IN]** to store the start frequency in the memory channel.
 - "ENDINPUT" appears on the sub-display.

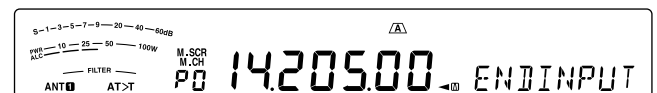

- 6 Turn the **Tuning** control or **MULTI/CH** control to select the end frequency.
- 7 Press **[M.IN]** to store the end frequency in the memory channel.
 - The previous data stored in the channel is overwritten.

10 MEMORY FEATURES

■ Confirming Start/ End Frequencies

Use this procedure to check the start and end frequencies that you stored in channels P0 to P9.

- 1 Press **[M/V]** to enter Memory Recall mode.
- 2 Turn the **MULTI/CH** control or press Mic **[UP]/[DWN]** to select a memory channel from P0 to P9.
- 3 Press **[A/B (A=B)]** to check the start frequency, then press **[A/B (A=B)]** again to check the end frequency.

■ Programmable VFO

Using the start and end frequencies that you stored in channels P0 to P9, Programmable VFO restricts the frequency range that you can tune with the **Tuning** control. One application of this function is to help you operate within the authorized frequency limits of your license.

- 1 Press **[M/V]** to enter Memory Recall mode.
- 2 Turn the **MULTI/CH** control or press Mic **[UP]/[DWN]** to select a memory channel from P0 to P9.

You can now only tune from the start frequency to the end frequency, using the **Tuning** control.

Note: Pressing Mic **[UP]/[DWN]** or turning the **MULTI/CH** control changes the memory channel number while in Programmable VFO mode.

MEMORY CHANNEL LOCKOUT

You can lock out memory channels that you prefer not to monitor during Memory Scan. Memory Scan is described in the next chapter {page 48}.

- 1 Press **[M/V]** to enter Memory Recall mode.
- 2 Turn the **MULTI/CH** control or press Mic **[UP]/[DWN]** to select the desired memory channel.
- 3 Press **[CLR]**.
 - Do not hold down the **[CLR]** key. Holding **[CLR]** for more than approximately 2 seconds will erase the contents of the memory channel.
 - A dot appears beside the right-most digit of the memory channel number to indicate the channel has been locked out.



- Repeatedly pressing **[CLR]** toggles between adding and removing the channel from the scan list.

ERASING MEMORY CHANNELS

If there are memory channels that you will not recall in the future, you may prefer erasing the contents of those channels.

- 1 Press **[M/V]** to enter Memory Recall mode.
- 2 Turn the **MULTI/CH** control or press Mic **[UP]/[DWN]** to select the desired memory channel.
 - You can also select a channel by entering a 2-digit number. Press **[ENT]**, **[7 (3)]**, **[10 (4)]** for example.
- 3 Press and hold **[CLR]**.
 - A long beep sounds to confirm that the channel data has been erased.

MEMORY CHANNEL NAME

You can assign a name to each memory channel, with a maximum of 8 alpha-numeric characters.

Note: You cannot name the Quick Memory channels.

- 1 Press **[M/V]** to enter Memory Recall mode.
- 2 Turn the **MULTI/CH** control or press Mic **[UP]/[DWN]** to select a memory channel.
- 3 Press **[Q-MR]**.
- 4 Turn the **MULTI/CH** control or press **[M.IN]/[SCAN (SG.SEL)]** to select the desired alpha-numeric character. You can move the cursor to the left by pressing **[Q-M.IN]**, or to the right by pressing **[Q-MR]**. Press **[CL]** to erase the character at the cursor.
- 5 After selecting all the necessary characters for the memory channel name, press **[MENU]** to store the name.
- 6 When you recall a memory channel with a name, the name is displayed on the sub-display along with the memory channel number.

Available alphanumeric characters:

A B C D E F G H I J K L M N O P Q(q) R S T U V W X
Y Z (space) * + - / 0 1 2 3 4 5 6 7 8 9

QUICK MEMORY

Quick Memory is designed to quickly and temporarily save data without specifying a particular memory channel. Use Quick Memory to store data you will not use in future operating sessions. For example, as you tune across the band looking for DX, it is convenient to store stations that you want to contact. You can quickly jump between several different memory channels as you monitor them.

Quick Memory channels can store the following data:

VFO A frequency and operating mode	VFO B frequency and operating mode
RIT ON/ OFF	XIT ON/ OFF
RIT/ XIT offset frequency	FINE ON/ OFF
Noise Blanker ON/ OFF	DSP Beat Cancel OFF/ 1/ 2

DSP Noise Reduction OFF/ 1/ 2	IF Notch
DSP filter bandwidth	Simplex/ Split

NUMBER OF QUICK MEMORY CHANNELS

This transceiver provides up to 10 Quick Memory channels. You can adjust the number of available channels by accessing Menu No. 21 and selecting “3”, “5” (default), or “10”.

STORING INTO QUICK MEMORY

Each time you store a new frequency, all previously stored frequencies are bumped to the next respective Quick Memory channel. When all 10 memory channels contain frequencies, storing one more frequency bumps the contents of memory channel 9 off the stack (the data is lost).

The following diagram illustrates how the Quick Memory stacks the data in memory each time you press **[Q-M.IN]**.

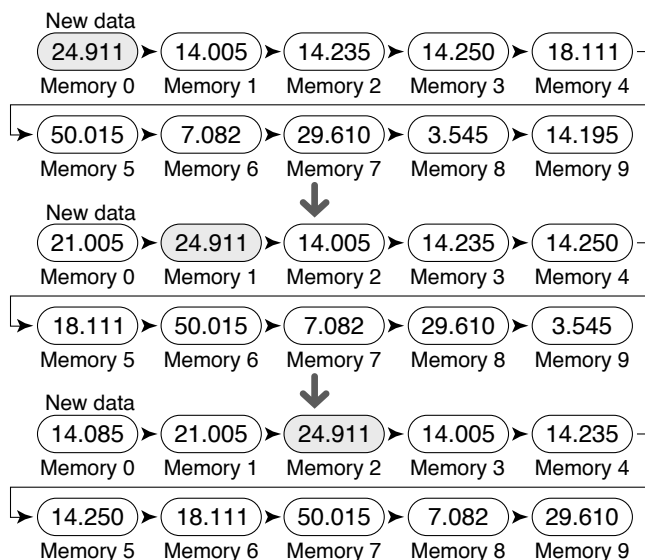

You can store data in the Quick Memory only when you operate the transceiver in VFO mode.

- 1 Select the frequency, mode, etc., on the transceiver VFO.
- 2 Press **[Q-M.IN]**.
 - Each time you press **[Q-M.IN]**, the current VFO data is written to the Quick Memory.

Note: When RIT or XIT is ON, the ON status and the offset will also be stored.

RECALLING QUICK MEMORY CHANNELS

You can recall a Quick Memory channel only when you operate the transceiver in VFO mode.

- 1 Press **[Q-MR]**.
 - The current memory channel number appears.
 - If there is no data stored in any Quick Memory channel, the data cannot be recalled to the current VFO; an error beep sounds.
- 2 Turn the **MULTI/CH** control to select a Quick Memory channel.
 - You cannot change memory channels while transmitting.
- 3 To exit, press **[Q-MR]** again.

Note: Memory channels cannot be changed while using the TF-SET function.

TEMPORARY FREQUENCY CHANGES

After recalling a Quick Memory channel, you can temporarily change the data without overwriting the contents of the channel. You can change the frequency even when you select “oFF” in Menu No. 22.

- 1 Press **[Q-MR]**.
- 2 Turn the **MULTI/CH** control to select a Quick Memory channel.
- 3 Change the frequencies and associated data.
- 4 To store the changed data in the Quick Memory, press **[Q-M.IN]**.
 - This action stores the new data in the current channel and bumps the old frequency to the next higher Quick Memory channel.
- 5 To exit, press **[Q-MR]** again.

Note: Memory channel data can also be changed while using the TF-SET function.

QUICK MEMORY → VFO TRANSFER

This function copies the contents of the recalled memory channel to the VFO.

- 1 Recall a Quick Memory channel.
- 2 Press **[M>V]**.

Note: Pressing **[M>V]** after temporarily changing the recalled data copies the new data to the VFO.

ERASING QUICK MEMORY CHANNELS

- 1 Recall a Quick Memory channel.
- 2 Press and hold **[CLR]**.
 - A confirmation message appears on the display.
- 3 Press **[CLR]**.
 - The channel data has been erased.

11 SCAN

Scan is a useful function for hands-off monitoring of your favorite frequencies. By becoming comfortable with all types of Scan, you will increase your operating efficiency.

This transceiver provides the following types of scans:

Scan Type		Purpose
Normal Scan	VFO Scan	Scans the entire frequency range of the transceiver.
	Program Scan	Scans the specific frequency ranges stored in Memory channels P0 ~ P9.
Memory Scan	All-Channel Scan	Scans all Memory channels, from 00 ~ 99, P0 ~ P9, and E0 ~ E9.
	Group Scan	Scans the specific Memory channel groups.
Quick Memory Scan		Scans the Quick Memory channels.

Note:

- ◆ While using CTCSS in FM mode, Scan stops only for the signals that contain the same CTCSS tone that you selected.
- ◆ Pressing Mic [PTT] causes Scan to stop.

NORMAL SCAN

While operating the transceiver in VFO mode, 2 types of scanning are available.

• VFO Scan

The transceiver scans the entire frequency range of the transceiver. For example, if you are operating and receiving on the transceiver's VFO A at 14.195.00 MHz, it scans all the frequencies in the range of 30.00 kHz to 59.999.99 MHz. (Refer to the available VFO frequency range in the specifications.)

• Program Scan

By programming the start and end frequency in Memory channels P0 ~ P9, you can limit the scanning frequency range. Since there are 10 memory channels (P0 ~ P9) available for specifying the start and end frequencies, you can select 1 or more (a maximum of 10) ranges to scan. This is useful when you are waiting for a DX station on a certain frequency but the station may appear on a slightly higher or lower frequency.

VFO SCAN

VFO Scan scans the entire frequency range that is available for the current VFO. When the Program Scan frequency range is not programmed or no Scan Group is selected for the Program Scan, the transceiver also scans the entire frequency range available for the current VFO.

The memory channel numbers P0 ~ P9 have alias names, "VGROUP". "VGROUP-0" represents channel P0, "VGROUP-1" represents channel P1, "VGROUP-2" represents channel P2, and so on up to

"VGROUP-9" which represents channel P9.

If one or more Program Scan frequency ranges are programmed in VGROUP-0 to 9 (Memory channel numbers P0 ~ P9 in other words):

- 1 Press and hold [**SCAN (SG.SEL)**] in VFO mode.
 - "VGROUP-n" appears on the sub-display (where n represents a number from 0 to 9).
- 2 Turn the **MULTI/CH** control to select the Program Scan memory (VGROUP-0 to VGROUP-9). As you select the channel, "on" or "off" appears on the frequency display. "on" signifies that the selected VGROUP is active for the Program Scan and "off" signifies that the selected VGROUP is inactive for the Program Scan.



Configure all P.SCAN channels (VGROUP-0 ~ VGROUP-9) as "off" by pressing [**SCAN (SG.SEL)**].

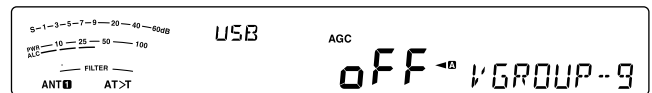

- 3 Press and hold [**SCAN (SG.SEL)**] or press [**CLR**] to return to the current VFO mode.
- 4 Press [**SCAN (SG.SEL)**] to start the VFO Scan.
- 5 Press [**SCAN (SG.SEL)**] or [**CLR**] to stop the VFO Scan.

Note:

- ◆ While scanning, you can change the scan speed by turning the **RIT/ XIT** control. Turn the control clockwise/ counterclockwise to decrease/ increase the scan speed. The speed indicator appears on the sub-display, where P1 is the fastest speed and P9 is the slowest.
- ◆ You cannot change the VFO Scan speed in FM mode.

PROGRAM SCAN

Program Scan monitors the range between the start and end frequencies that you have stored in Memory channels P0 ~ P9 (VGROUP-0 ~ 9). Refer to "STORING FREQUENCY RANGES" {page 43} for details on how to store the start and end frequencies to these Memory channels.

You can select a maximum of 10 memory channels (VGROUP-0 to 9) and sequentially scan the frequency ranges that you stored in these channels. If the current VFO frequency falls within the selected VGROUP frequency range, Program Scan starts from the VGROUP number and then continues to scan the next larger VGROUP number. If the current VFO frequency is outside all of the VGROUP frequency ranges, Program Scan starts from the smallest VGROUP number that is selected as "on" (each VGROUP can be set to either "on" or "off").

Note: At least one of the valid Program Scan channels (from P0 to P9) must be programmed and selected to perform Program Scan. If no P.SCAN (memory channel P0 ~ P9) is selected for Program Scan, the transceiver performs VFO Scan (above).

- 1 Press [**A/B (A=B)**] to select VFO A or VFO B.
- 2 Press and hold [**SCAN (SG.SEL)**].



- 3 Turn the **MULTI/CH** control or press Mic **[UP]/[DWN]** to select the memory channel (VGROUP–0 to VGROUP–9). As you select the Memory Channel, “on” or “oFF” appears on the main frequency display. “on” signifies that the memory channel is active for the Program Scan and “oFF” signifies that the memory channel group is inactive for the Program Scan.
- 4 To activate the Program Scan frequency range, select the desired VGROUP number by turning the **MULTI/CH** control. Then, press **[M.IN]** to select “on” for the VGROUP (channel). When a channel is activated for Program Scan, “on” appears on the display.

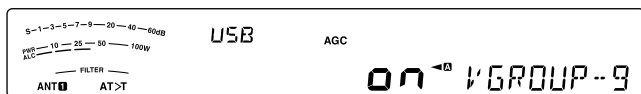

- 5 Press and hold **[SCAN (SG.SEL)]** or press **[CLR]** to return to the current VFO mode.
- 6 Press **[SCAN (SG.SEL)]** to start the Program Scan.
 - To quickly move toward a desired frequency while scanning, turn the **Tuning** control or the **MULTI/CH** control, or press Mic **[UP]/[DWN]**.
 - Turning the **RIT/XIT** control clockwise decreases the scan speed and counterclockwise increases the speed, except while in FM mode. The current scan speed is shown on the display; P1 is the fastest speed and P9 is the slowest.
 - While in FM mode, Scan automatically stops on a frequency where a signal is present. The transceiver will either remain on that channel for a short time (Time-Operated mode) or until the signal drops out (Carrier-Operated mode), depending on which mode you select via Menu No. 26 {page 50}.
- 7 To stop Scan, press **[SCAN (SG.SEL)]** or **[CLR]**.

Note:

- ◆ If you have turned the **SQL** control clockwise, far beyond the squelch threshold while in FM mode, Scan may fail to stop at a channel where a signal is present. If this happens, turn the **SQL** control slightly counterclockwise.
- ◆ If you press **[SCAN (SG.SEL)]** before storing any frequency range for memory channels P0 to P9, the transceiver starts VFO scan.
- ◆ When the current receive frequency is within one of the ranges that you selected with channel numbers, Scan starts with the current frequency. The operating mode stored in the memory channel is used.
- ◆ The operating mode can be changed while scanning, but the memory channel will be overwritten with the changed mode.
- ◆ When the current Scan range is smaller than a single step of the **MULTI/CH** control, turning the control clockwise causes Scan to jump to the start frequency, and counterclockwise to the end frequency.
- ◆ Starting Program Scan switches OFF the RIT and XIT functions.
- ◆ While in FM mode, Program Scan monitors rounded off frequencies regardless of the Menu No. 14 setting.

PROGRAM SCAN PARTIALLY SLOWED

You can specify a maximum of 5 frequency points for each memory channel from P0 to P9 so that Program Scan slows down the scanning speed. To specify the slow down frequency points, first program the start and end frequencies into a memory channel (P0 ~ P9).

- 1 Access Menu No. 23 to confirm that the function is ON (default is ON).
- 2 You can further configure the slow down frequency width. Access Menu No. 24 to select the range from 100 Hz to 500 Hz (default is 300 Hz).

Note: If you select, for example, 500 Hz for Menu No. 20, the Program Scan slows down to a ± 500 Hz width, centering the frequency you marked below.

- 3 Press **[M/V]**, then turn the **MULTI/CH** control to recall the memory channel (P0 ~ P9) for which you want to specify the scan slow down frequencies.
- 4 Turn the **Tuning** control to the center frequency point that you want the Program Scan to slow down. Then, press **[Q-M.IN]** to mark the slow down frequency point.
 - “★” appears.
- 5 Repeat step 4 to specify the center slow down frequency points.
 - You can specify a maximum of 5 frequency points for each channel.
- 6 If you want to clear a slow down frequency point that you previously stored, select the frequency that you stored, then press **[Q-M.IN]** at this frequency spot where “★” appears.
 - A confirmation beep sounds and “★” disappears.
 - To clear all slow down frequency points, press and hold **[Q-M.IN]**.
- 7 Press **[M/V]** to return to VFO mode.
- 8 Press **[SCAN (SG.SEL)]** to start the Program Scan with the slow down frequency point(s).

Note:

- ◆ During Program Scan, you can turn the **RIT/XIT** control to adjust the scanning speed. Turn the control clockwise/counterclockwise to slow down/ speed up the scan. The Program Scan speed indicator appears on the main display during Program Scan; P1 is the fastest speed and P9 is the slowest.
 - ◆ You cannot change the Program Scan speed in FM mode.
 - ◆ Although you can specify the Program Scan slow down frequency point in FM mode, it does not function.
 - ◆ When copying a Program Memory Channel, all frequency points are cleared.
-

11 SCAN

SCAN HOLD

This function stops Program Scan for approximately 5 seconds, then resumes Scan when you jump to the desired frequency by turning the **Tuning** control or the **MULTI/CH** control, or by pressing Mic **[UP]/ [DWN]**.

To use this function, access Menu No. 25, and select "on". The default is OFF.

MEMORY SCAN

Memory Scan monitors all memory channels in which you have stored frequencies (All-channel Scan) or only a desired group of memory channels (Group Scan).

Scan automatically stops at a channel where a signal is present, regardless of the operating mode. The transceiver will either remain on that channel for a short time (Time-Operated mode) or until the signal drops out (Carrier-Operated mode). Use Menu No. 26 to select the mode. The default is "to" (Time-Operated).

SCAN RESUME

The transceiver stops scanning at the frequency (or memory channel) where a signal is detected. It then continues scanning according to which resume mode you have selected. You can choose one of the following modes. The default is Time-Operated mode.

- **Time-Operated mode ("to")**

The transceiver remains on a busy frequency (or memory channel) for approximately 6 seconds, then continues to scan, even if the signal is still present.

- **Carrier-Operated mode ("co")**

The transceiver remains on the busy frequency (or memory channel) until the signal drops out. There is a 2 second delay between signal dropout and scan resumption.

- 1 Press **[MENU]**, then press **[Q-M.IN]/ [Q-MR]** or turn the **MULTI/CH** control to select Menu No. 26.
- 2 Press **[M.IN]/ [SCAN (SG.SEL)]** to select "to" (Time-Operated) or "co" (Carrier-Operated).

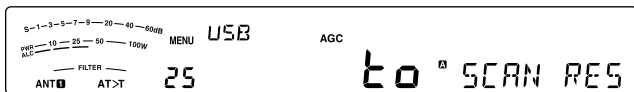

- 3 Press **[MENU]** to exit Menu mode.

You can lock out the memory channels that you prefer not to monitor while scanning (refer to "Memory Channel Lockout").

ALL-CHANNEL SCAN

Use the following procedure to scan all the memory channels that contain frequency data in sequence, ignoring the Memory Group number.

- 1 Select Time-Operated or Carrier-Operated mode via Menu No. 26.
- 2 Press **[M/V]** to enter Memory Recall mode.
- 3 Turn the **SQL** control to adjust the squelch threshold to mute the speaker.
- 4 Press and hold **[SCAN (SG.SEL)]** to enter Scan Group Select mode.
 - Turn the **MULTI/CH** control to select the Memory channel group.
 - MGROUP-0 represents Memory channels 0 ~ 9, MGROUP-1 represents Memory channels 10 ~ 19 and so on up to MGROUP-9 which represents Memory channels 90 ~ 99, MGROUP-P which represents Memory channels P0 ~ P9 and MGROUP-E which represents Memory channels E0 ~ E9.
- 5 As you select the Memory Groups using the **MULTI/CH** control, press **[M.IN]** to select "on" for all Memory Groups.
- 6 Press and hold **[SCAN (SG.SEL)]** to return to Memory Recall mode.
- 7 Press **[SCAN (SG.SEL)]** to start All-channel Scan.
 - Scan starts from the current memory channel and ascends up through the channel numbers. (The scan direction cannot be changed.)
 - To jump to a desired channel while scanning, turn the **MULTI/CH** control, or press Mic **[UP]/ [DWN]**.
- 8 To stop Scan, press **[SCAN (SG.SEL)]** or **[CLR]**.

Note:

- ◆ If you have turned the **SQL** control clockwise, far beyond the squelch threshold, Scan may fail to stop at a channel where a signal is present. If this happens, turn the **SQL** control slightly counterclockwise.
- ◆ Starting Memory Scan switches OFF the RIT and XIT functions.

GROUP SCAN

110 memory channels are divided into 11 groups so that you can select one or more groups to be scanned, depending on the situation.

■ Memory Group

When you store frequency data in a memory channel, the memory channel belongs to one of 11 groups as shown below.

MGROUP-0	Memory Channel Nos. 00 ~ 09
MGROUP-1	Memory Channel Nos. 10 ~ 19
MGROUP-2	Memory Channel Nos. 20 ~ 29
MGROUP-3	Memory Channel Nos. 30 ~ 39
MGROUP-4	Memory Channel Nos. 40 ~ 49
MGROUP-5	Memory Channel Nos. 50 ~ 59
MGROUP-6	Memory Channel Nos. 60 ~ 69
MGROUP-7	Memory Channel Nos. 70 ~ 79
MGROUP-8	Memory Channel Nos. 80 ~ 89
MGROUP-9	Memory Channel Nos. 90 ~ 99
MGROUP-P	Memory Channel Nos. P0 ~ P9
MGROUP-E	Memory Channel Nos. E0 ~ E9

■ Scan Group Select

You can select one or more groups to be scanned. First, select the groups to be scanned.

- 1 Press **[M/V]** to enter Memory Recall mode.
 - "M.CH" appears.
- 2 Press and hold **[SCAN (SG.SEL)]** to enter Scan Group Select mode.
- 3 As you turn the **MULTI/CH** control, the MGROUP number on the sub-display changes.
 - MGROUP-0 represents Memory channels 0 ~ 9, MGROUP-1 represents Memory channels 10 ~ 19 and so on up to MGROUP-9 which represents Memory channels 90 ~ 99 and MGROUP-P which represents Memory channels P0 ~ P9.
- 4 Press **[M.IN]** to select "on" to add the group to the Group Scan list.
 - If you do not want to scan the selected Group, press **[SCAN (SG.SEL)]** to select "oFF".
- 5 Press and hold **[SCAN (SG.SEL)]** or **[CLR]** to exit the Scan Group Select mode.

■ Performing Group Scan

Group Scan starts with the smallest group number and repeats the sequence. For example, if you selected "on" for MGROUP-3, MGROUP-5, and MGROUP-7, the transceiver scans the channels in MGROUP-3 > MGROUP-5 > MGROUP-7 > MGROUP-3 and so on.

- 1 Select Time-Operated or Carrier-Operated mode via Menu No. 26.
- 2 Press **[M/V]** to enter Memory Recall mode.
- 3 Turn the **SQL** control to adjust the squelch threshold.
- 4 Press **[SCAN (SG.SEL)]** to start Memory Group Scan.
 - Scan ascends up through the channel numbers. (The scan direction cannot be changed.)
 - To jump to a desired channel while scanning, turn the **MULTI/CH** control or press and hold Mic **[UP]/ [DWN]**.
- 5 To stop Scan, press **[SCAN (SG.SEL)]** or **[CLR]**.

Note:

- ◆ If you have turned the **SQL** control clockwise, far beyond the squelch threshold, Scan may fail to stop at a channel in which a signal is present. If this happens, turn the **SQL** control slightly counterclockwise.
- ◆ When the current channel is within one of the groups that you selected, Scan starts with the current channel.
- ◆ When the current channel is outside all the groups that you selected, Scan starts with the group number that is larger than and closest to the group number of the current channel.
- ◆ Starting Memory Scan switches OFF the RIT and XIT functions.

QUICK MEMORY SCAN

- 1 Press **[Q-MR]** to enter Quick Memory mode.
- 2 Press **[SCAN (SG.SEL)]** to start Quick Memory Scan.
 - Scan starts from the current quick memory channel and ascends up through the channel numbers. (The scan direction cannot be changed.)
- 3 To stop Scan, press **[SCAN (SG.SEL)]** or **[CLR]**.

12 OPERATOR CONVENIENCES

ANTENNAS

ANT 1/ ANT 2

Two antenna connectors are available for the HF/ 50 MHz band on the TX/ RX unit rear panel.

Press and hold **[PRE (ANT 1/2)]** to select ANT 1 or ANT 2.

- “ANT 1” or “ANT 2” appears to indicate which antenna is selected.

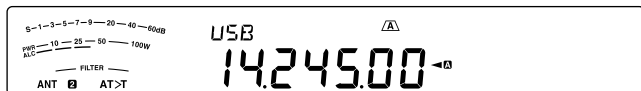

RX ANT

Press and hold **[ATT (RX ANT)]** to toggle the RX ANT between enabled and disabled.

- “RX” appears when the RX ANT is enabled.

DRV

Press and hold **[METER (DRV)]** to switch the Drive output (DRO) or Antenna output (ANT) between enabled and disabled.

Drive output : Use the standard input of 1 mW for the linear amplifier and other connections.

- “DRV” appears when the Drive output is enabled.

Antenna output: The DRV terminal functions as an antenna output terminal for an external receiver. With this function, the RX signal that is input from the currently selected antenna (ANT1, ANT2, or RX ANT) is split in the middle, with one input to the RX circuit and the other output to the DRV terminal.

- “*” appears when the DRV (Antenna output) is enabled.

Note:

- ◆ When you use the Antenna output function, due to the loss of the splitter, the receive sensitivity and gain decreases by approximately 3 dB.
- ◆ During transmission, the transmission output will leak a little through internal isolation (approximately -20 dBm at 50 MHz).
- ◆ The ON/OFF status of the Antenna output function is stored separately in the 50 MHz band and HF band.

■ Selecting the DRV Connector Function

- 1 Press **[MENU]**, then press **[Q-M.IN]/ [Q-MR]** or turn the **MULTI/CH** control to access Menu No. 85.
- 2 Press **[M.IN]/ [SCAN (SG.SEL)]** to select “DRO” or “ANT”.
- 3 Press **[MENU]** to exit Menu mode.

The ANT 1, ANT 2, RX ANT, and DRV settings will automatically be stored in the antenna band memory. The next time you select the same band, the same antenna will be automatically selected.

Antenna Selection Frequency Range (MHz)	
0.03 ~ 0.522	10.5 ~ 14.5
0.522 ~ 2.5	14.5 ~ 18.5
2.5 ~ 4.1	18.5 ~ 21.5
4.1 ~ 6.9	21.5 ~ 25.5
6.9 ~ 7.5	25.5 ~ 30.0
7.5 ~ 10.5	30.0 ~ 60.0

Note: Connect an external tuner to the ANT 1 connector only, then select ANT 1. The internal antenna tuner will be automatically bypassed when the transceiver is switched ON.

APO (Auto Power OFF)

You can set the transceiver to switch OFF automatically if no keys or controls are pressed or adjusted for a certain period of time. One minute before the transceiver switches OFF, “CHECK” is output in Morse code.

- 1 Press **[MENU]**, then press **[Q-M.IN]/ [Q-MR]** or turn the **MULTI/CH** control to access Menu No. 86.
- 2 Press **[M.IN]/ [SCAN (SG.SEL)]** to select the APO time from “oFF”, “60”, “120”, or “180” minutes.
- 3 Press **[MENU]** to exit Menu mode.

Note:

- ◆ The APO function works even if the transceiver is scanning.
- ◆ The APO timer starts counting down when no key presses, no control adjustments, and no command (COM connector) sequences are detected.

AUTOMATIC ANTENNA TUNER

As explained in “ANTENNA CONNECTION” {page 1}, matching the impedance of the coaxial cable and antenna is important. To adjust the impedance between the antenna and the transceiver, you have the choice of using the internal antenna tuner or an external antenna tuner. This section describes how to use the internal antenna tuner. For the external antenna tuner, consult the instruction manual that comes with the tuner.

- 1 Select the transmit frequency.
- 2 Press and hold **[PRE (ANT 1/2)]** to select “ANT 1” or “ANT 2”.
 - If the external antenna tuner (AT-300) is connected to the ANT 1 connector, select ANT 2 to use the internal antenna tuner. The internal antenna tuner is automatically bypassed if the external antenna tuner is connected to ANT 1.
- 3 Press and hold **[AT (TUNE)]**.
 - CW mode is automatically selected and tuning begins.
 - “AT>T” blinks and the TX-RX LED lights red.
 - To cancel tuning, press **[AT (TUNE)]** again.

- If the SWR of the antenna system is extremely high (more than 10:1), an alarm (“SWR” in Morse code) sounds and the internal antenna tuner is bypassed. Before attempting to tune again, adjust the antenna system to lower the SWR.
- 4 Monitor the display and check that tuning has successfully finished.
- If the tuning was successful, “AT>T” stops blinking and the red TX-RX LED turns OFF.
 - If tuning does not finish within approximately 20 seconds, an alarm (“5” in Morse code) sounds. Press **[AT (TUNE)]** to stop the alarm and tuning.
 - If you want the transceiver to stay in transmission mode after the tuning completes, access Menu No. 57 and select “on”.
 - To pass received signals through the internal antenna tuner, access Menu No. 58 and select “on”. When this function is ON, “R<AT” appears. This may reduce interference on the receive frequency.

Note:

- ◆ The internal antenna tuner will not tune outside the available transmission frequency limits.
- ◆ Pressing **[AT (TUNE)]** for more than 1 second while transmitting interrupts transmitting and starts tuning.
- ◆ While using CW Full Break-in, the internal antenna tuner will be in-line for both transmission and reception.
- ◆ Tuning automatically turns OFF in approximately 60 seconds. “AT” disappears and the error beeps stop.
- ◆ Tuning may still continue when the SWR meter indicates 1:1. This happens due to the tuning algorithm; this is not a malfunction.
- ◆ Even though the SWR meter shows more than one segment, the internal antenna tuner may not re-tune. This happens because of an SWR calculation algorithm tolerance.
- ◆ If tuning does not finish even though the SWR meter indicates smaller than 3:1, adjust the antenna system to lower the SWR, then attempt to tune again.
- ◆ Tuning may not reach an SWR of 1:1, depending on the transceiver conditions.
- ◆ The AT-300 cannot perform tuning on the 50 MHz band.

PRESETTING

After each successful tuning session, the internal antenna tuner Preset memory function stores the position of the tuning capacitor in memory. The position of the capacitor is stored for each of the antenna tuner bands (see the following table) and for each antenna connector (ANT 1 and ANT 2).

Press **[AT (TUNE)]**.

- “AT>T” or “R<AT” appears, showing that the antenna tuner is in-line (not bypassed).
- Each time you go across the antenna tuner band, the internal antenna tuner Preset memory is automatically recalled to position the tuning capacitor without the need for retuning. If no preset data exists for a particular band/ antenna combination, then the default data of 50 Ω is used.

Note: Tuning may restart in order to obtain the optimum matching condition even though the current antenna tuner band has the preset data.

Internal Antenna Tuner Preset Frequency Range (MHz)	
0.03 ~ 1.85	14.1 ~ 14.5
1.85 ~ 2.50	14.5 ~ 18.5
2.50 ~ 3.525	18.5 ~ 21.15
3.525 ~ 3.575	21.15 ~ 21.5
3.575 ~ 3.725	21.5 ~ 25.5
3.725 ~ 4.1	25.5 ~ 29.0
4.1 ~ 6.9	29.0 ~ 30.0
6.9 ~ 7.05	30.0 ~ 51.0
7.05 ~ 7.1	51.0 ~ 52.0
7.1 ~ 7.5	52.0 ~ 53.0
7.5 ~ 10.5	53.0 ~ 60.0
10.5 ~ 14.1	

AUTO MODE

You can configure a maximum of 32 frequency borders (VFO A and B) to change the operating mode automatically as you change the VFO frequency.

As a default, the following modes are programmed on each operating band.

0.03 MHz ~ 9.5 MHz: LSB

9.5 MHz ~ 60 MHz: USB

To add the frequency borders to the Auto Mode selection:

- 1 With the transceiver power OFF, press and hold **[LSB/USB] + [⏏]** to turn the transceiver ON.
 - “AUTOMODE” appears on the sub-display.
- 2 Select an Auto Mode frequency memory channel number by turning the **MULTI/CH** control.
 - Auto Memory channels 00 to 31 are available.
- 3 Turn the **Tuning** control to select a desired frequency border (or enter the frequency with the keypad {page 29}) to change the operating mode.
- 4 Press **[LSB/USB]**, **[CW/FSK (REV)]**, **[FM/AM (FM-N)]**, or **[DATA]** until the desired communication mode appears.
- 5 Repeat steps 2 ~ 4 until you have added all the data.
- 6 Press **[CLR]** to exit the Auto Mode frequency configuration.

To activate the Auto Mode function:

- 1 Press **[MENU]**, then press **[Q-M.IN]/ [Q-MR]** or turn the **MULTI/CH** control to select Menu No. 27.
- 2 Press **[M.IN]** to select “on”.
- 3 Press **[MENU]** to exit Menu mode.

Note: When using Auto Mode Frequency configuration, you cannot use the Frequency Entry History function.

12 OPERATOR CONVENIENCES

The table below is an example of setting the Auto Mode frequency.

Channel No.	Frequency (MHz)	Mode	Operation Range (MHz)
00	1.620	AM	$0.030 \leq f < 1.620$
01	2.000	CW	$1.620 \leq f < 2.000$
02	3.500	LSB	$2.000 \leq f < 3.500$
03	3.525	CW	$3.500 \leq f < 3.525$
04	10.100	LSB	$3.525 \leq f < 10.100$
05	10.150	CW	$10.100 \leq f < 10.150$
06	14.000	USB	$10.150 \leq f < 14.000$
07	14.070	CW-R	$14.000 \leq f < 14.070$
08	14.112	FSK	$14.070 \leq f < 14.112$
09	18.068	USB	$14.112 \leq f < 18.068$
10	18.110	CW	$18.068 \leq f < 18.110$
11	21.000	USB	$18.110 \leq f < 21.000$
12	21.070	CW	$21.000 \leq f < 21.070$
13	21.125	FSK-R	$21.070 \leq f < 21.125$
14	21.150	CW	$21.125 \leq f < 21.150$
15	24.890	USB	$21.150 \leq f < 24.890$
16	24.930	CW	$24.890 \leq f < 24.930$
17	28.000	USB	$24.930 \leq f < 28.000$
18	28.070	CW	$28.000 \leq f < 28.070$
19	28.150	FSK	$28.070 \leq f < 28.150$
20	28.200	CW	$28.150 \leq f < 28.200$
21	29.000	USB	$28.200 \leq f < 29.000$
22	30.000	FM-DATA	$29.000 \leq f < 30.000$
23	50.000	USB	$30.000 \leq f < 50.000$
24	50.100	CW	$50.000 \leq f < 50.100$
25	51.000	USB	$50.100 \leq f < 51.000$
26	52.000	FM	$51.000 \leq f < 52.000$
27	52.000	LSB	
28	52.000	LSB	
29	52.000	LSB	
30	52.000	LSB	
31	52.000	LSB	

- The frequencies for channels 27 ~ 31 have not been configured, but because they are the same frequency as channel 26, they will be FM mode $51.0 \text{ MHz} \leq f < 52.0 \text{ MHz}$.
- Since the frequencies above 52.0 MHz have not been configured, they will be USB mode $52.0 \text{ MHz} \leq f < 60.0 \text{ MHz}$

BEEP FUNCTION

The Beep function provides you confirmation of entry, error status, and malfunctions of the transceiver.

Although you can turn the beep function OFF by accessing Menu No. 05, we recommend you leave it ON in order to detect unexpected errors and malfunctions. You can also change the output level of the beeps by accessing Menu No. 05 and selecting "1" to "20".

The transceiver generates the following Morse code to tell you which mode is selected when you change operating modes:

Mode	Morse Code Output
USB	••– (U)
LSB	•–•• (L)
CW	–••• (C)
FSK	•–• (R)
AM	•– (A)
FM	••–• (F)
USB-DATA	••– –•• (UD)
LSB-DATA	•–•• –•• (LD)
CW-R	–••• •–• (CR)
FSK-R	•–• •–• (RR)
AM-DATA	•– –•• (AD)
FM-NAR	••–• –• (FN)
FM-DATA	••–• –•• (FD)
FM-NAR-DATA	••–• –• –•• (FND)

The transceiver also generates the following warning, confirmation, and malfunction beeps.

Beep Type	Meaning
Short, high pitch	A valid key is pressed.
Double, high pitch	A secondary function is selected.
3 times, high pitch	The third function is accepted.
Long, high pitch	A key entry is accepted, Scan starts, or AT tune has completed.
Short, regular	A function is turned OFF.
Short, low pitch	An invalid key is pressed.
Morse "UL"	The internal PLL circuit unlock status is detected.
Morse "S"	CW Auto Tune cannot complete, or an invalid frequency is entered.
Morse "5"	AT Tune cannot be completed within the specified time.
Morse "SWR"	The antenna's SWR is too high (over 10:1) to perform AT tune.
Morse "CHECK"	1 minute before the APO (Auto Power Off) function switches the transceiver OFF, a protection circuit is ON. or an invalid voltage is detected.
Morse "BT"	Waiting for a CW message to be recorded.

Beep Type	Meaning
Morse "AR"	The current message memory is full.

DISPLAY

BRIGHTNESS

The brightness of the LCD display can be selected from OFF, and 1 to 6 .

- 1 Press [MENU], then press [Q-M.IN]/ [Q-MR] or turn the MULTI/CH control to access Menu No. 02.
- 2 Press [M.IN]/ [SCAN (SG.SEL)] to select "oFF", "1", "2", "3", "4", "5", or "6".
- 3 Press [MENU] to exit Menu mode.

BACKLIGHT COLOR

You can manually change the display illumination to suit the lighting conditions where you are operating.

- 1 Press [MENU], then press [Q-M.IN]/ [Q-MR] or turn the MULTI/CH control to select Menu No. 03.
- 2 Press [M.IN]/ [SCAN (SG.SEL)] to select "1" (amber), "2" to "9" (mixed colors), or "10" (green).
- 3 Press [MENU] to exit Menu mode.

PANEL KEY DOUBLE FUNCTION RESPONSE TIME

You can set the response time of double function panel keys to normal or fast. The default setting is normal.

- 1 Press [MENU], then press [Q-M.IN]/ [Q-MR] or turn the MULTI/CH control to select Menu No. 04.
- 2 Press [M.IN]/ [SCAN (SG.SEL)] to select "1" (0.2 second), "2" (0.5 second) or "3" (1 second)
- 3 Press [MENU] to exit Menu mode.

LINEAR AMPLIFIER CONTROL

To connect the linear amplifier to the REMOTE connector on the rear panel and to operate in the HF or 50 MHz band, you can configure to enable or disable the control signal state and the transmission delay time.

- 1 Press [MENU], then press [Q-M.IN]/ [Q-MR] or turn the MULTI/CH control to select Menu No. 59 (HF) or 60 (50 MHz).
- 2 Press [M.IN]/ [SCAN (SG.SEL)] to select "oFF", "1", "2", "3", "4", or "5".
- 3 Press [MENU] to exit Menu mode.

Setting	RL Terminal Operation *1	Relay Operation *2	Delay *3
oFF	-	-	-
1	While TX: 12 V	OFF	OFF
2	While TX: 12 V	ON	OFF
3	While TX: 12 V	ON	ON
4	While TX: Short to GND	OFF	OFF
5	While TX: Short to GND	OFF	ON

*1: Semiconductor Switch output. When transmitting, set it to either perform a voltage output or a short circuit to GND. It is possible to perform the operation quietly, without activating the relay. As a guide, a current of 10 mA or lower can be controlled. In order to protect the internal circuit, a resistance of 100 Ω is inserted in series and the voltage is shifted according to the flow of the electric current. For example, when an electric current of 10 mA flows, the voltage decreases (when set as 1/2/3) or increases (when set as 4/5) by 1 V. Use a range that does not cause any problems with your equipment.

*2: Mechanical Relay Operation. You can switch the signal of the high voltage like a vacuum tube linear amplifier. It is possible to control the terminal voltage of TL-922 (approximately -140 V).

*3: This function extends the time from when the transmission starts to when the signal is sent (normally approximately 10 ms), and from when the transmission ends to when audio output starts to be received (normally approximately 25 ms). When using a linear amplifier or other device that takes a relatively long time to switch between receiving and transmitting, or transmitting and receiving, such as the TL-922, you can prevent problems such as noise or malfunctions.

Delay Time:

CW/FSK: approx. 25 ms

SSB/AM/FM: approx. 45 ms

12 OPERATOR CONVENIENCES

LOCK FUNCTIONS

FREQUENCY LOCK FUNCTION

Frequency Lock disables some keys and controls to prevent you from accidentally activating a function or changing the current settings.

Press and hold **[FINE (F.LOCK)]** to turn the Frequency Lock function ON or OFF.

- “**FO**” appears while this function is ON.



The following keys and controls are disabled by Frequency Lock:

Key	Comments
Tuning control	Still operates in TF-SET mode.
MULTI/CH control	Still operates for changing setting modes.
[ENT]	
[M.IN]	Still operates for character selection and for changing setting modes.
[SCAN]	Still operates for character selection and for changing setting modes. Also still operates for setting up scan groups (press and hold).
Mic [UP]	Still operates in TF-SET mode (in VFO mode) during Menu mode when the Mic key paddle operation is ON.
Mic [DWN]	Still operates in TF-SET mode (in VFO mode) during Menu mode when the Mic key paddle operation is ON.
[A/B]	
[M/V]	
[SPLIT]	
Band direct key	
[M>V]	
[LSB/USB]	
[CW/FSK]	
[FM/AM]	Still operates to change between FM and FM Narrow (press and hold).
[DATA]	
[MHz]	
[FINE]	Still operates to cancel Frequency Lock (press and hold).
[CWT]	Still operates to turn AGC ON/OFF (press and hold).

Key	Comments
[CLR]	Still operates to turn Memory Channel Lockout ON/OFF. Also still operates to end a setting mode.
[Q-MR]	Still operates to edit a Memory name.
[Q-M.IN]	Still operates to set or remove a Slow Scan Frequency point (press) or to remove all frequency points (press and hold).

PROGRAMMABLE FUNCTION KEYS

TRANSCEIVER FRONT PANEL

There are 6 PF (Programmable Function) keys on the transceiver front panel: **[PF A]**, **[PF B]**, **[RIT]**, **[XIT]**, **[CL]**, and **[MULTI/CH]**. You can assign your own desired functions to these 6 keys by accessing Menu Nos. 87 (PF A), 88 (PF B), 89 (RIT), 90 (XIT), 91 (CL), 92 (MULTI/CH: except CW mode) and 93 (MULTI/CH: CW mode).

MICROPHONE KEYS

There are 4 microphone PF (Programmable Function) keys: **[PF1]**, **[PF2]**, **[PF3]**, and **[PF4]**. You can assign your own desired functions to these 4 keys via Menu Nos. 94 to 97. You can also reprogram the Mic **[UP]**/**[DWN]** keys with your desired function by accessing Menu Nos. 99 and 98.

Assign one of the following functions to each PF key. Selecting “OFF” assigns no function to the PF key.

No.	Function	Remark
00 ~ 99	Menu No. 00 ~ 99	
120	RX ANT	
121	ATT	
122	ANT1/2	
123	PRE	
124	VOX	Press and hold: enter the level setup mode.
125	PROC	Press and hold: enter the level setup mode.
126	SEND	
127	AT	Press and hold: start the antenna tuning.
128	CAR	
129	MIC	
130	TX-MONI	
131	PWR	[MULT/CH] default (except CW mode)
132	DELAY	
133	KEY	[MULT/CH] default (CW mode)

No.	Function	Remark
134	DRV	Selected ANT: ANT OUT on/off
135	METER	
136	LSB/USB	
137	CW/FSK	Press and hold: REV
138	FM/AM	Press and hold: NAR
139	DATA	When the CW Morse decoder is ON, press and hold: enter the threshold level adjustment mode.
140	F.LOCK	
141	FINE	
142	IF FIL	Press and hold: enter the bandwidth display.
143	NB	Press and hold: enter the level setup mode.
144	NR	Press and hold: enter the level setup mode.
145	AUTO NOTCH	
146	BC	
147	NOTCH	Press and hold: NOTCH WIDE.
148	SPLIT	Mic [PF2] default
149	TF-SET	
150	A=B	
151	A/B	Mic [PF1] default
152	M/V	
153	M.IN	
154	M>V	Mic [PF3] default
155	Q-M.IN	
156	Q-MR	
157	MHz	
158	SCAN	
159	MENU	
160	CH1	
161	CH2	
162	CH3	
163	CH4	
164	RX	
165	RIT	[RIT] default
166	XIT	[XIT] default
167	CL	[CL] default
168	AGC/T	Press and hold: enter the tone setup mode.
169	AGC OFF	
170	CW T.	
200	VOICE1	[PF A] default
201	VOICE2	[PF B] default

No.	Function	Remark
202	VOICE3	The lower meter when transmitting
203	MONITOR	Mic [PF4] default
204	TX TUNE 1	
205	TX TUNE 2	
206	DATA SEND	The input voice from the data terminal is transmitted
207	DWN	Mic [DWN] default
208	UP	Mic [UP] default
209	EMERGENCY	Emergency frequency call (K type only)
OFF		No function

Note:

- ◆ Assigned key functions may not work, depending on the setting.
- ◆ [AGC SEL] can be used in modes other than FM mode, and can set a step level of the chosen AGC time constant (FAST/ SLOW).
- ◆ [TONE SEL] can also be used in FM mode while TONE or CTCSS is ON,

DSP RX EQUALIZER

EQUALIZING RECEIVING AUDIO

Use Menu No. 37 to change the receiver frequency responses of the target signal. You can select one from 8 different receiver profiles including the default flat response. Selecting any of the following items from the Menu causes "R<EQ" to appear on the display.

- **Off (oFF):**
Slightly attenuates (1 kHz or higher audio frequencies).
- **High boost 1 (hb1):**
Emphasizes higher audio frequencies.
- **High boost 2 (hb2):**
Emphasizes higher audio frequencies but lower audio frequency attenuation is less than High boost1 (hb1).
- **Formant pass (FP):**
Improves clarity by suppressing audio frequencies outside the normal voice frequency range.
- **Bass boost 1 (bb1):**
Emphasizes lower audio frequencies.
- **Bass boost 2 (bb2):**
Emphasizes lower audio frequencies but higher audio frequency attenuation is less than Bass boost1 (bb1).
- **Flat (FLAT):**
The flat frequency response.
- **User (U):**
Reserved for the ARCP software. Off is programmed at the factory as a default.

Note: The RX Equalizer can be set for each mode.

12 OPERATOR CONVENIENCES

RX MONITOR

RX monitor temporarily disables the squelch function to monitor the current frequency activities.

To use the RX Monitor function, first assign the function to a PF key (either on the front panel or the microphone).

- 1 Press **[MENU]**, then press **[Q-M.IN]/ [Q-MR]** or turn the **MULTI/CH** control to select Menu No. 87 to 99.
- 2 Press **[M.IN]/ [SCAN (SG.SEL)]** to select "203".
- 3 Press **[MENU]** to exit Menu mode.
- 4 Press the assigned **[PF]** key.
 - While pressing **[PF]**, the speaker unmutes.

TIME-OUT TIMER

The Time-out Timer limits the time of each transmission. It is also useful to prevent a long accidental transmission.

- 1 Press **[MENU]**, then press **[Q-M.IN]/ [Q-MR]** or turn the **MULTI/CH** control to access Menu No. 55.
- 2 Press **[M.IN]/ [SCAN (SG.SEL)]** to select "oFF", "3", "5", "10", "20", or "30" minutes.
- 3 Press **[MENU]** to exit Menu mode.

TRANSVERTER

If you have a transverter that converts the TS-590SG operating frequencies to other frequencies, you can use this TS-590SG transceiver as a transverter exciter. Consult the instruction manual that came with the transverter for interfacing to the TS-590SG transceiver.

FREQUENCY DISPLAY

- 1 Connect the transverter to the ANT 1, ANT 2, RX ANT, or DRV connector of the TS-590SG.
- 2 Select the exciter operating frequency on the transceiver.
 - The transverter will use this frequency as the reference for converting frequencies.
- 3 Press **[MENU]**, then press **[Q-M.IN]/ [Q-MR]** or turn the **MULTI/CH** control to access Menu No. 56.
- 4 Press **[M.IN]/ [SCAN (SG.SEL)]** to select "1".
 - The output power is automatically set to the lowest power for that frequency (default). Refer to "TX POWER" {below}.
- 5 Press **[MENU]** to exit Menu mode.
- 6 Press **[ENT]**, then set the target converting frequency using the numeric keys.
- 7 Press **[ENT]** to complete the entry.
 - The transceiver displays the target transverter frequency instead of the actual operating frequency.

Note:

- ◆ When using a transverter, not all the functions of this transceiver are available.
- ◆ When turning the transverter ON, the frequency entry history is cleared, thus you cannot use the frequency entry history function.
- ◆ When using an antenna tuner in the IN state and the transverter is turned ON, the antenna tuner is forced to the THRU state.

TRANSMISSION OUTPUT POWER

If Menu No. 56 is set to "1" {above}, the transceiver automatically decreases the output power to 5 watts. However, if you do not wish to decrease the output power, access Menu No. 56 and select "2"; the transceiver will transmit at full power.

Note: You are responsible for your transmission output power settings.

TX MONITOR

TX monitor allows you to monitor the on-going transmission sound. This is convenient when you want to check the modulation sound quality of the transmission. In FSK mode, you can monitor the FSK signal that the transceiver is transmitting.

- 1 Press and hold **[PWR (TX MONI)]**.
 - The current TX monitor setting appears on the sub-display.
- 2 Turn the **MULTI/CH** control to select the monitor sound level from "oFF", and "1" to "20".
- 3 Press **[CLR]** to store the selected TX monitor level.

Note:

- ◆ We recommend you use headphones when you monitor SSB, AM, or FM mode, in order to avoid howling.
- ◆ The CW transmission signal cannot be monitored using the TX monitor function. Use the TX sidetone function to monitor CW transmissions (Menu Nos. 06 and 40).

TX POWER

You can adjust the transmission output power by pressing **[PWR (TX MONI)]** and turning the **MULTI/CH** control. If more precise power adjustment is required, access Menu No. 54 and select "on". When this function is activated, the power adjustment steps change as shown in the table below.

Mode	Menu No. 54 OFF	Menu No. 54 ON
SSB/ CW/ FM/ FSK	5 ~ 100 W in steps of 5	5 ~ 100 W in steps of 1
AM	5 ~ 25 W in steps of 5	5 ~ 25 W in steps of 1

Note: The output power settings are stored independently for HF and 50 MHz. As shown in the table above, you can also store different output power settings for AM/ DATA and other modes for HF bands and the 50 MHz band.

TX TUNE

The TX Tune function allows you to adjust the antenna length, or tune the linear amplifier while transmitting a continuous CW signal.

To use the TX Tune function, first assign the function to a PF key (either the front panel or Microphone PF keys).

Method 1:

- 1 Press **[MENU]**, then press **[Q-M.IN]/ [Q-MR]** or turn the **MULTI/CH** control to select a Menu No. from 87 to 99.
- 2 Press **[M.IN]/ [SCAN (SG.SEL)]** to select “204” (TX TUNE 1).
- 3 Press **[MENU]** to exit Menu mode.
- 4 Press the assigned **[PF]** key.
 - The transceiver automatically switches to CW mode, and transmits a continuous carrier. The transceiver selects the SWR meter function automatically.
 - While in TX Tune mode, most keys are disabled.
 - The default output power is configured as 10 watts. However, you can adjust the output power using **[PWR (TX MONI)]** and the **MULTI/CH** control if necessary. The transceiver stores the new output power setting when you exit the TX Tune mode.
- 5 Press the assigned **[PF]** key again to exit the TX Tune mode.

Method 2:

- 1 Press **[MENU]**, then press **[Q-M.IN]/ [Q-MR]** or turn the **MULTI/CH** control to select a Menu No. from 87 to 99.
- 2 Press **[M.IN]/ [SCAN (SG.SEL)]** to select “205” (TX TUNE 2).
- 3 Press **[MENU]** to exit Menu mode.
- 4 Press and hold the assigned **[PF]** key.
 - The transceiver automatically switches to CW mode, and transmits a continuous carrier. The transceiver selects the SWR meter function automatically.
 - While in TX Tune mode, most keys are disabled.
 - The default output power is configured as 10 watts. However, you can adjust the output power using **[PWR (TX MONI)]** and the **MULTI/CH** control if necessary. The transceiver stores the new output power setting when you exit the TX Tune mode.
- 5 Release the assigned **[PF]** key to exit the TX Tune mode.

ADJUSTING THE TRANSMIT OUTPUT POWER FOR TX TUNE

While in TX Tune, press **[PWR]** to turn the transmission output power adjusting mode for TX Tune ON/OFF.

You can adjust the transmission output power of TX Tune by turning the **MULT/CH** control while in TX Tune mode.

- The TX Tune mode ON/OFF status is stored.

The following procedure shows how to set the transmission output power of TX Tune while in RX mode.

- 1 Press **[PWR (TX MONI)]** while receiving to enter the transmission output power adjusting mode.
- 2 Press the assigned **[PF]** key, “204” (TX TUNE 1) or “205” (TX TUNE 2), to enter the transmission output power adjusting mode for TX Tune.
 - “T.PWR” appears.
- 3 Turn the **MULTI/CH** control to select the transmission output power for TX Tune.
- 4 Press **[PWR (TX MONI)]** or **[CLR]** to exit the transmission output power adjusting mode for TX tune.

Note:

- ◆ While in the transmission output power adjusting mode for TX Tune, you can start TX Tune by pressing the PF key to which [TX TUNE 1] or [TX TUNE 2] is assigned.
- ◆ When you finish TX Tune, the transmission output power adjusting mode for TX Tune exits.

QUICK DATA TRANSFER

This transceiver has the capability to quickly and conveniently transfer the reception frequency and mode to another compatible transceiver. Compatible transceivers include:

TS-590SG/ 590S	TS-480HX/ SAT	TS-2000/X
TS-570S/ 570D	TS-870S	TS-990S

Data transfer could be useful while contesting. A spotting station that is searching for new contest multipliers can quickly transfer a frequency over to the running (main) station.

SETTING UP

■ Equipment Needed

In addition to a compatible transceiver, to transfer to a TS-990S, TS-590SG, TS-590S, TS-480HX/ SAT, TS-2000/X, TS-570S/D, or TS-870S, you must have 1 cross-wired cable with a DB-9 female connector at both ends.

■ Connections

For diagrams on how to connect the 2 transceivers, refer to “CONNECTING PERIPHERAL EQUIPMENT” {page 69}.

12 OPERATOR CONVENIENCES

USING QUICK TRANSFER

When connecting with another TS-990S, TS-590SG, TS-590S, TS-480HX/ SAT, TS-2000/X, TS-570S/D/SG/DG, or TS-870S, use the same COM connector baud rate on each transceiver.

Note: While transferring data, other functions may work slower.

■ Transferring Data

The TS-590SG transceiver works as the Master, sending data to the Slave transceiver.

- 1 Turn ON the Transfer function of each transceiver.
 - On the TS-590SG, access Menu No. 64 and select "on". For the compatible transceiver, refer to the instruction manual that came with the transceiver.
- 2 On the Master, while in VFO mode, select an operating frequency and mode.
- 3 On the Master, press [Q-M.IN].
 - The displayed data is stored in Quick Memory channel 0 on the Master and transferred to the Slave.

Note: If the Master has RIT switched ON, the offset frequency is added to the reception frequency to be transferred.

■ Receiving Data

The TS-590SG transceiver works as the Slave, receiving data from the Master transceiver. The Slave can receive data using either Quick Memory channel 0 or the VFO.

- 1 Switch ON the Transfer function of each transceiver.
 - On the TS-590SG access Menu No. 64 and select "on". For the compatible transceiver, refer to the instruction manual that came with the transceiver.
- 2 On the Slave, access Menu No. 65 and select either "oFF" (QUICK MEMO channel 0) or "on" (the VFO).
 - The default is OFF (QUICK MEMO).
- 3 On the Master, perform the appropriate operation to send data.
 - For the correct method, refer to the instruction manual that came with the transceiver.

Note:

- ◆ If you always use the TS-590SG for receiving only, activate the TX Inhibit function via Menu No. 66, to avoid unintentional transmission.
 - ◆ When the Slave receives data using the VFO programmed with a simplex frequency, the received data replaces the data on both VFOs. On the Slave, both RIT and XIT are set to OFF.
 - ◆ When the Slave receives data using the VFOs programmed with split frequencies, the received data replaces the data only on the TX side of the VFO. On the Slave, XIT is set to OFF but RIT is not changed.
-

COMPUTER CONTROL

By connecting this transceiver to a computer, you can change the computer into an electronic console from which you can remotely control functions of the transceiver. This capability makes remote operation of your transceiver possible from across the room, from another room, or when coupled with other commercially available products and where lawful, from another city, state, or country via an internet connection.

SETTING UP

■ Equipment Needed

When connecting the TS-590SG to a PC USB port:

- USB 2.0 conformed (base) port
- Commercially available AB type USB 2.0 cable
- Transceiver control application
- Pre-installed virtual COM port driver, on the PC. (The driver is available at the website listed below.)

When connecting the TS-590SG to a PC COM port:

- A PC equipped with a COM (serial) port
- 1 straight cable. This cable must have a DB-9 female connector at one end, and a DB-9 or a DB-25 female connector that mates with the COM port of your computer at the other end.
- Transceiver control application

To create your programs, access the **KENWOOD** website and download the TS-590SG command reference documents (pdf format) for details:

http://www.kenwood.com/ii/products/info/amateur/software_download.html

■ Connections

To connect the transceiver to a computer, refer to the diagram in "CONNECTING PERIPHERAL EQUIPMENT" {page 69}.

Note: Before connecting this transceiver to a computer, switch OFF the power to both the transceiver and the computer.

COMMUNICATION PARAMETERS

In order to control the transceiver with the computer, you must first choose the communication parameters.

- 1 On the computer, configure your transceiver control application for 8 data bits, 1 stop bit, and no parity.
- 2 On the transceiver, select the same transfer rate via Menu No. 67 (COM port) or 68 (USB port).
 - The defaults are 9600 bps and 1 stop bit for Menu No. 67 and 115200 bps and 1 stop bit for Menu No. 68.
 - Only a baud rate of 4800 bps uses 2 stop bits.
- 3 Press [MENU] to exit Menu mode.
- 4 Turn the power OFF and then back ON to implement the change.

EXTERNAL AUDIO SETTINGS

■ Selecting a Data Transmission Line

Depending on how you connect your transceiver to a PC, you will need to set a data transmission line type. Access Menu No. 69 and select “ACC2” (default) or “USB”.

■ Audio Level Settings

You can set the input and output audio levels of an ACC2 connection via Menu Nos. 73 and 74, and the input and output audio levels of a USB connection via Menu Nos. 71 and 72. Each setting has a range of 0 to 9, with a default setting of 4.

Additionally, you can mix beep tones, the sidetone, and the Voice guide for an ACC2/USB audio output by accessing Menu No. 75 and selecting “on” (whereby the PC will confirm the sounds being output from the transceiver speaker).

SELECTING THE AUDIO SOURCE FOR TRANSMISSION IN DATA MODE

In Data mode, you can select to use the microphone or the data communication input signal from the ACC2 connector or USB connector as the input signal that will be transmitted by operating the front panel SEND key, microphone PTT (SS), pin 13 (SS) of the ACC2 connector, or pin 3 (SS) of the REMOTE connector.

- 1 Press [MENU], then press [Q-M.IN]/ [Q-MR] or turn the MULTI/CH control to select Menu No. 70.
- 2 Press [M.IN]/ [SCAN (SG.SEL)] to select “FRONT” or “REAR”.
- 3 Press [MENU] to exit Menu mode.

CHANGING THE SIGNAL FOR THE COM TERMINAL

Send the PSQ (SQL control signal) and PKS signal through the COM terminal.

- 1 Turn the transceiver power OFF.
- 2 Press [FM/AM (FM-N)] + [⏻].
 - “PSQ/PKS” momentarily appears, and the RTS/CTS signal is replaced with the PSQ/PKS signal at the COM terminal.
- 3 Repeat steps 1 and 2 to return to normal operation.
 - “CTS/RTS” momentarily appears.

The operation of the output signal for each setting is as follows:

	COM Terminal		PC
CTS/ RTS	TxD	➔	RxD
	RxD	➔	TxD
	RTS	➔	CTS
	CTS	➔	RTS
	GND		GND

	COM Terminal		PC
PSQ/ PKS	TxD (stopped)	➔	RxD
	RxD (stopped)	➔	TxD
	PSQ	➔	CTS
	PKS	➔	RTS
	GND		GND

Normal PC commands (ARCP, ARHP, or SKY COMMAND SYSTEM II) will not work when this function is turned ON.

- When operating the TS-590SG as a base station, using VoIP or similar software, set Menu No. 84 to “SQL”.

At the same time, if you are using CTCSS, set Menu No. 82 to “2” and confirm that the frequency is not already in use and is not causing any interference.
- When turning the power OFF and the VoIP software misdetects a busy signal, set Menu No. 83 to “OPEN”.
- When not using the USB terminal, besides a serial cable, create and connect a sound input/output cable. In this case when connecting to sound equipment and the audio output level is too high, change the level setting in Menu No. 73.

CONTROLLING THE TS-590SG FROM A PC

If a PC and the TS-590SG are connected using a serial cable {page 71}, you can remotely control the functions of the TS-590SG from a PC. Download the free ARCP-590G software from the following URL:

http://www.kenwood.com/i/products/info/amateur/software_download.html

The detailed remote controlling instructions are available in accompanied documents and help file.

REMOTELY CONTROLLING THE TS-590SG ON THE NETWORK

In addition to the ARCP-590G program, the ARHP-590G program can also be downloaded from the above site. This ARHP-590G program is an ARCP-590G host program that allows a user who is connected in the network to remotely control the TS-590SG transceiver from a distant location. If you make interface cables that transfer the audio between the TS-590SG transceiver and the PC on the host transceiver, you can receive signals and transmit your voice over the network. For detailed information, download the ARHP-590G program and consult the accompanied documents.

Note: The ARHP-590G does not support voice communication. In order to use voice communications, you must also use universal VoIP software.

OPTIONAL VGS-1 VOICE GUIDE & STORAGE UNIT

The optional VGS-1 unit allows you to record 30 second (maximum) voice messages to memory channels 1 and 2, and 15 second (maximum) voice messages to memory channels 3 and 4. After recording a message via your transceiver microphone, you can then transmit those recorded messages. It also announces the key function and frequencies each time you press a key (Voice announcement). Since the incoming reception signal is processed in digital data in the transceiver, the VGS-1 can be configured to constantly store the incoming audio signals in the background. If you wish, you can store the last 30 seconds of the incoming signal to the VGS-1 for the later playback (Constant recording).

For information on how to install the VGS-1 unit, refer to "INSTALLING OPTIONS" {page 76}.

RECORDING MESSAGES

This section explains how to record a single message.

- 1 Select SSB, FM, or AM mode.
 - Select a mode that you wish to transmit.
- 2 Press and hold **[CH1 (REC)]** to record the message for channel 1.
 - BT in Morse code sounds and "AP 1 -" appears.

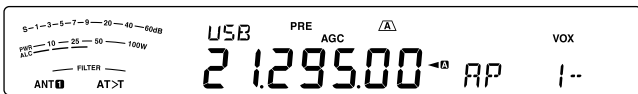

- To quit recording your message, press **[CLR]**.
- 3 Press **[MIC (CAR)]**, then turn the **MULTI/CH** control to adjust the microphone gain so that the voice input level is not beyond the ALC level zone.
 - 4 Hold **[CH1 (REC)]** and speak into your microphone.
 - Four channels are available for recording messages. Press **[CH2 (REC)]**, **[CH3 (REC)]**, or **[RX/4 (REC)]** in place of **[CH1 (REC)]**, in steps 3 and 4 to record the message on a different channel.
 - If Constant Recording is active, **[RX/4 (REC)]** is unavailable for message recording.
 - 5 Release the key when you have finished recording your message.
 - When the maximum recording time passes, recording automatically stops.
 - The contents of the channel is overwritten with the new message.
 - "WRITING" appears while the transceiver is storing the message data to the VGS-1 flash memory.
 - 6 Repeat steps 2 to 5 to record a message on another channel.

Note:

- ◆ Pressing **[⏏]** cancels the recording in progress and clears the memory channel.
- ◆ The audio source for messages is normally input from the Mic, but using a personal computer, you can record messages that are input from the rear terminal as the audio source. Refer to the PC Command list for more details.

MESSAGE PLAYBACK

You can play back the message in channel 1, 2, 3, or 4 to check or send them. It is also possible to make a longer message by consecutively playing back the messages of more than one channel, linking them together.

You can even repeatedly send a longer, linked message by using the Repeat function. To switch this function ON, access Menu No. 62 and select "on" (default is OFF). Then, select the repeat interval time in Menu No. 63 (default is 10 seconds).

Note:

- ◆ Pressing **[⏏]** cancels the playback in progress.
- ◆ The settings in Menu Nos. 56 and 57 are shared with CW Message Playback described in "CW MESSAGE MEMORY" {page 35}.

■ Checking Messages

- 1 Select SSB, FM, or AM mode.
 - Select the same mode when you recorded the message.
 - Confirm that the VOX function is OFF.
- 2 Press **[CH1 (REC)]**, **[CH2 (REC)]**, **[CH3 (REC)]**, or **[RX/4 (REC)]**, depending on which channel you want to check.
 - For example, "AP 1--" appears while playing back the message in channel 1.
 - To interrupt playback, press **[CLR]**.
 - When Menu No. 62 is "oFF", press and hold the current playback channel key to repeatedly play back the message saved to that key (A display such as "AP 1111" appears for the channel key you pressed.). To cancel the playback, press any channel key or **[CLR]**.
- 3 To play back another message in sequence, press the corresponding key (**[CH1 (REC)]**, **[CH2 (REC)]**, **[CH3 (REC)]**, or **[RX/4 (REC)]**) while the first message is being played.
 - Repeat playback, by pressing and holding the keys, does not work during consecutive message playback.
 - Up to 4 channels can be queued.

■ Sending Messages

- 1 Select SSB, FM, or AM mode.
 - Select the same mode when you recorded the message.
- 2 Press **[VOX (LEV)]** to switch VOX ON or OFF.
 - If you switched VOX ON, skip step 3.
- 3 Press **[SEND]** or hold Mic **[PTT]**.

- 4 Press **[CH1 (REC)]**, **[CH2 (REC)]**, **[CH3 (REC)]**, or **[RX/4 (REC)]**, depending on which channel you want to use.
 - For example, “AP 1 – –” appears while playing back the message in channel 1.
 - To interrupt playback, press **[CLR]**.
- 5 To play back another message in sequence, press the corresponding key (**[CH1 (REC)]**, **[CH2 (REC)]**, **[CH3 (REC)]**, or **[RX/4 (REC)]**) while the first message is being played.
 - Up to 4 channels can be queued.
- 6 If you pressed **[SEND]** or Mic **[PTT]** in step 3, press **[SEND]** again or release Mic **[PTT]**.
 - To adjust the input and output levels for the Mic Gain and Speech Processor, adjust them in sending the messages. (The levels for the Mic transmission and voice message transmission are stored separately.)

Erasing a Recorded Message

- 1 Press and hold **[CH1 (REC)]**, **[CH2 (REC)]**, **[CH3 (REC)]**, or **[RX/4 (REC)]** to select the message you want to erase.
 - “AP n – –” appears, where “n” represents the channel number.
- 2 To erase the recorded message, press and hold the same key as in step 1 (**[CH1 (REC)]**, **[CH2 (REC)]**, **[CH3 (REC)]**, or **[RX/4 (REC)]**) while simultaneously pressing **[CLR]**.
 - A beep sounds and the message is erased.

Changing Inter-message Interval Time

For repetitive message playback, you can change the interval between each series of messages. Use Menu No. 63, and select the interval time in the range of 0 to 60 seconds.

Changing Message Playback Volume

Turning the **AF** control does not change the volume for the message playback. To change the message playback volume, access Menu No. 07 to select the playback volume level from “1” to “20” or “oFF”.

CONSTANT RECORDING

By utilizing the digital recording capability of the VGS-1, you can configure the VGS-1 to store the last 30 seconds of communications (transmitted signals and received signals when the squelch opens). You can play back the last 30 seconds of communications to confirm what has been heard.

To activate the Constant Recording function, access Menu No. 61 and select “on” (default). “” appears and the transceiver starts recording the signal in the background. When you press and hold **[RX/4 (REC)]**, the VGS-1 stores the last 30 seconds (maximum) of the reception audio signal to the flash memory. While writing the audio signal data to the flash memory, “WRITING” appears.

To play back the stored reception signal, press **[RX/4 (REC)]**. To quit, press **[CLR]**.

Note:

- ◆ While Menu No. 61 is ON, you cannot use channel 4 (RX/4) to record and playback a voice message. However, the message in channel 4 is not erased. When the Constant Recording function is turned OFF (Menu No. 55 is OFF), you can playback the message on channel 4.
- ◆ While “” is not displayed, such as the VGS-1 is playing back a message or the Voice Guide function is working, the Constant Recording function temporarily pauses.
- ◆ When you record a new message to the VGS-1, the 30 second Constant Recording buffer is cleared.
- ◆ You cannot transmit a stored audio signal that is recorded with the Constant Recording function.

VOICE GUIDE

When the optional VGS-1 is installed, each time you change the transceiver mode such as VFO A/B or Memory Recall, the transceiver automatically announces the new mode. In addition, you can program each **[PF]** key which makes the transceiver announce the displayed information by pressing it.

The tables below indicate the transceiver announcements when the settings are changed. Additionally, pressing the **[PF]** key will perform specific announcements depending on whether VOICE1, VOICE2, or VOICE3 is selected.

VOICE1:

- When VOICE 1 auto announcement is ON (“1” or “2”) (Menu No. 11), the transceiver settings are automatically announced any time the settings are changed.
 - 1: The frequency is announced in changing the memory channel.
 - 2: The Memory Name is announced when the memory channel is changed. (If a Memory Name is not set, the frequency is announced.)
- Pressing **[PF]** will announce the currently displayed settings.
- During a voice announcement, pressing **[PF]** will cancel the announcement.

Operations using VOICE1

Operation	Announcement
IF filter selection (High Cut)	“High” + Setting value ¹
IF filter selection (Low Cut)	“Low” + Setting value ¹
IF filter selection (Width)	“Width” + Setting value ¹
IF filter selection (Shift)	“Shift” + Setting value ¹
Tone frequency selection/ when tone ID scanning is complete	“Tone” + Setting value ¹
CTCSS frequency selection/ when CTCSS ID scanning is complete	“CTCSS” + Setting value ¹
NR1 level setup	“NR1” + Setting value ¹
NR2 level setup	“NR2” + Setting value ¹

12 OPERATOR CONVENIENCES

Operation	Announcement
Memory scan group setup	<p>“Memory scan group” + Group No. + “Off/On”</p> <ul style="list-style-type: none"> When selecting a group number, the group number and “Off/On” is announced. When the settings are changed, only “Off/On” is announced.
Program/VFO scanning section setup	<p>“VFO” + “Scan” + “Group” + Section defined No. + “Off/On”</p> <ul style="list-style-type: none"> When selecting the section defined number, the section defined number and “Off/On” is announced. When the settings are changed, only “Off/On” is announced.
VOX gain level setup	“VOX gain” + Setting value ¹
Speech processor input level setup	“Processor in” + Setting value ¹
Speech processor output level setup	“Processor out” + Setting value ¹
Noise Blanker “1” or “2” level setup	“Noise blanker” “1” or “2” + Setting value ¹
Mic Gain adjustment	“Mic gain” + Setting value ¹
Keying Speed selection	“Keying Speed” + Setting value ¹
TX power adjustment	“TX power” + Setting value ¹
VOX Delay time setup	“VOX delay” + Setting value ¹
Break-in Delay time setup	“Break-in delay” + Setting value ¹
TX Monitor volume adjustment	“TX monitor” + Setting value ¹
Carrier level adjustment	“Carrier” + Setting value ¹
AGC constant time AGC setting (FAST)	“Fast” + Setting value ¹
AGC constant time AGC setting (SLOW)	“Slow” + Setting value ¹
While in Menu mode	“Menu” + Menu number + Setting value ¹
While in transmission output power adjusting mode for TX Tune	“T” + “Power” + Setting value ¹
While in threshold level adjustment mode for the CW Morse decoder	“CW” + “THR” + Setting value ¹

¹ During continuous operation, only the setting value is announced.

Status Settings using VOICE1

Status	Announcement
<p>Press [⏻] While in VFO mode</p>	“VFO” + (“S” +) ¹ “A/B” + Frequency (+ “X/R/XR” + RIT/XIT Frequency) ⁴
<p>Press [A/B (A=B)] Changing VFO A or B while in VFO mode (TF-SET ON/OFF is stored)</p>	<p>(“S” +)¹ “A/B” + Frequency (+ “X/R/XR” + RIT/XIT Frequency)⁴</p> <ul style="list-style-type: none"> Announces when Menu No. 11 is “1” or “2”
<p>Press [1.8] ~ [50] or [GENE] Press [LSB/USB]/ [CW/FSK (REV)]/ [FM/AM (FM-N)] Changing the frequency while in VFO mode Changing the mode while in VFO mode</p>	<p>Frequency (+ “X/R/XR” + RIT/XIT Frequency)⁴</p> <ul style="list-style-type: none"> Announces when Menu No. 11 is “1” or “2”
<p>Press [M/V] While in Memory channel mode</p>	“Channel” + Channel number + (“S” +) ¹ Frequency (+ “X/R/XR” + RIT/XIT Frequency) ⁴
<p>Turn the MULTI/CH control Changing the memory channel while in Memory channel mode Changing the mode while in Memory channel mode</p>	<p>Channel number + (“S” +)¹ Frequency</p> <ul style="list-style-type: none"> Announces when Menu No. 11 is “1” or “2”
<p>Hold or Release [TF-SET] TF-SET ON/OFF while in Memory scroll mode</p>	<p>(“S” +)¹ Frequency (+ “X/R/XR” + RIT/XIT Frequency)⁴</p> <ul style="list-style-type: none"> Announces when Menu No. 11 is “1” or “2”
<p>Editing the channel name (While in character selection)</p>	Selected character or symbol. (“@”, “/” and “Space” are not announced.)
<p>Press [Q-MR] While in Quick memory mode</p>	“Quick memory” + Channel number + (“S” +) ¹ “A/B” + Frequency (+ “X/R/XR” + RIT/XIT Frequency) ⁴
<p>Turn the MULTI/CH control Changing the memory channel while in Quick memory mode</p>	<p>Channel number + (“S” +)¹ “A/B” + Frequency (+ “X/R/XR” + RIT/XIT Frequency)⁴</p> <ul style="list-style-type: none"> Announces when Menu No. 11 is “1” or “2”
<p>Press [M.IN] While in Memory scroll mode</p>	<p>Empty Channel: “Memory in” + Channel number + “Blank”</p> <p>Stored Channel: Channel number + (“S” +)¹ Frequency</p>

Status	Announcement
Turn the MULTI/CH control Changing the channel number while in Memory scroll mode	Empty Channel: Channel number + "Blank" Stored Channel: Channel number + ("S" +) ¹ Frequency • Announces when Menu No. 11 is "1" or "2"
Press [ENT] While in frequency/memory channel number entry mode	"Enter"
Press [ENT], then press the number keys Enter the number while in frequency/memory channel number entry mode	Entered number
Press [ENT], then turn the MULTI/CH control Displaying the frequency history while in Frequency entry mode	Frequency
Press the number keys Enter the number while in memory scroll channel number entry mode	"Enter" + Entered number
Press [LSB/USB] + [⏏] While in Auto setting mode	"Auto" + Channel number + Frequency • Announces when Menu No. 11 is "1" or "2"
Turn the MULTI/CH control Changing the channel number while in Auto setting mode	Channel number + Frequency • Announces when Menu No. 11 is "1" or "2"
Press the number keys Changing the frequency/mode while in Auto setting mode	Frequency • Announces when Menu No. 11 is "1" or "2"
Press and hold [FINE] Turning the frequency lock ON/OFF	"Frequency lock" + "On"/"Off"
Press [RIT] or [XIT] While in RIT/XIT adjusting mode	"X/R/XR" + RIT/XIT Frequency ⁴
Press [METER (DRV)] Changing the meter type	ALC meter: "A" SWR meter: "R" COMP meter: "C"
Press and hold [METER (DRV)] Changing the Drive output	Drive output enabled: "D" + "On" Drive output disabled: "D" + "Off"

Status	Announcement
Press and hold [METER (DRV)] Changing the Antenna output	Drive output enabled: "A" + "On" Drive output disabled: "A" + "Off"
Press [FM/AM (FM-N)] + [⏏] Changing the output signal for the PC control terminal ²	CTS/RTS Output Mode: "CTSRTS on" PSQ/PKS Output Mode: "PSQPKS on"
Press [A/B (A=B)] + [⏏], then turn the MULTI/CH control Reset confirmation during VFO reset ²	"VFO reset?"
Press [A/B (A=B)] + [⏏], then turn the MULTI/CH control Reset confirmation during Full reset ²	"Full reset?"

- ¹ Announced when operating in Split-frequency mode.
- ² Announced even when the auto Voice announcement is OFF.
- ³ When auto Voice announcement is ON, various configuration images appear on the display. When modifications are made to these settings, the new setting is announced.
- ⁴ "X/R/XR" + RIT/XIT frequency are announced when either RIT or XIT is ON. "X/R/XR" are announced as "X" if the only XIT is ON, "R" if the only RIT is ON, and "XR" if both XIT and RIT are ON.

VOICE2:

- Pressing [PF] will announce the current state of the S meter/ RF meter.
- During a voice announcement, pressing [PF] will cancel the announcement.

VOICE2 Announcements

S meter		PWR meter	
Dot position	Announcement	Dot position	Announcement
0	S 0	0	P 0
1 ~ 3	S 1	1 ~ 3	P 5
4 ~ 5	S 2	4 ~ 6	P 10
6	S 3	7 ~ 12	P 25
7 ~ 8	S 4	13 ~ 18	P 50
9	S 5	19 ~ 23	P 75
10 ~ 11	S 6	24 ~ 30	P 100
12	S 7		
13 ~ 14	S 8		
15	S 9		
16 ~ 19	10 dB		
20	20 dB		
21 ~ 24	30 dB		
25	40 dB		
26 ~ 29	50 dB		
30	60 dB		

12 OPERATOR CONVENIENCES

VOICE3:

- Pressing [PF] will announce the current state of the SWR meter/ ALC meter/ COMP meter.
- During a voice announcement, pressing [PF] will cancel the announcement.

VOICE3 Announcements

SWR meter		ALC meter	
Dot position	Announcement	Dot position	Announcement
0	R	0	A 0
1	R 1.0	1	A 1
2 ~ 6	R 1.5	2	A 2
7 ~ 11	R 2.0	~	~
12 ~ 16	R 3.0	13	A 13
17 ~ 24	R 5.0	14	A 14
25 ~ 30	R OVER	15 ~	A OVER

COMP meter	
Dot position	Announcement
0	C 0 dB
1 ~ 10	C 10 dB
11 ~ 20	C 20 dB
21 ~ 30	C OVER

■ Voice Guide Announcement Volume

Turning the **AF** control does not change the volume for the Voice Guide announcement. To change the announcement volume, access Menu No. 08 and select the volume level from “1” to “20” or “oFF”.

■ Voice Guide Announcement Speed

If you feel the Voice Announcement speed is too slow or too fast, you can adjust the Voice Announcement speed. Five different speeds can be configured. Access Menu No. 09 and select “0” to “4”, where 0 is the slowest speed and 4 is the fastest. The default speed is 1.

■ Voice Guide Announcement Language

If you mistakenly change the announcement language, you can change it back to English by accessing Menu No. 10 and selecting “EN”.

EMERGENCY CALL (K TYPE ONLY)

Section 97.401(d) of the regulations governing amateur radio in the United States permit emergency amateur communications on 5167.5 kHz by stations in or within 92.6 km of the state of Alaska. This frequency is for use only when the immediate safety of human life and/or property are threatened, and is never to be used for routine communications.

Press [**EMERGENCY**] to change to the Emergency channel (5167.5 kHz/ USB).

- [**EMERGENCY**] can be programmed onto a PF key.
- When entering Emergency mode, “EMERGENCY” momentarily appears on the sub-display.

Note:

- RIT/XIT turns OFF automatically when entering Emergency mode.
- The transceiver will not switch to the Emergency channel if you are using the constant recorder and are either transmitting, receiving a voice call, or receiving a CW call.

CROSSBAND REPEATER

If you have a KENWOOD FM transceiver (K type) with a 6 pin mini DIN connector, you can set up the TS-590SG transceiver and the FM transceiver as a crossband repeater. The FM transceiver will receive signals you transmit from the additional VHF or UHF transceiver when both transceivers are set with the same frequency. The signal is then routed to the TS-590SG transceiver and retransmitted on the frequency you have set on the TS-590SG transceiver. Likewise, signals received on the TS-590SG transceiver are routed to the FM transceiver and retransmitted to the transceiver you have with you, allowing you to hear the received call in a distant location.

To interface between the TS-590SG transceiver and FM transceiver (K type), refer to “CROSSBAND REPEATER” {page 75}.

Note: For the repeater function to operate, the squelch levels of both transceivers (TS-590SG and FM transceiver) must be adjusted properly so that no background noise can be heard; the transmission is controlled by monitoring the squelch status only.

OPERATION

The crossband repeater function uses 2 frequency bands to receive and transmit signals. When a signal is received on one band, it is retransmitted on the other band.

- Select a transmission/ reception VHF or UHF frequency on the FM transceiver.
- Confirm the PTT icon is visible on the crossband repeater frequency on the FM transceiver.
- Select the same frequency for the terminal transceiver.
- Select a HF/ 50 MHz frequency on the TS-590SG transceiver.
- Adjust the squelch threshold level so that both the TS-590SG and FM transceivers mute.

- 6 On the TS-590SG, press **[MENU]**, then turn **MULTI/CH** control to select Menu Nos. 80 and 81.
- 7 Press **[M.IN]** to select “on”.
 - When the TS-590SG transceiver’s squelch opens, the FM transceiver simultaneously retransmits the incoming audio signal on the VHF or UHF frequency.
 - When the FM transceiver’s squelch opens, the TS-590SG transceiver retransmits the incoming audio signal on the HF/ 50 MHz frequency.
- 8 Access Menu Nos. 73 and 74 and press **[M.IN]/[SCAN (SG.SEL)]** to adjust the input/ output audio level.
- 9 To quit the FM repeater operation, disconnect the interface cable between the transceivers, then access Menu Nos. 80 and 81 on the TS-590SG transceiver and select “oFF”.

DX PACKETCLUSTER TUNE

If you have a TH-D72(A/E)/ TM-D710/G(A/E)/ RC-D710/ TM-D700(A/E), you can connect it to the TS-590SG transceiver to use the DX PacketCluster Tune function. Connect the 2 transceivers with a cross-wired DB-9 cable as shown on page 74.

- 1 On the TS-590SG, press **[MENU]**, then turn **MULTI/CH** control to select Menu No. 67.
- 2 Press **[M.IN]/ [SCAN (SG.SEL)]** to select the same communication baud rate configured on the TH-D72(A/E)/ TM-D710/G(A/E)/ RC-D710/ TM-D700(A/E).
- 3 Tune to the DX PacketCluster node frequency on the TH-D72(A/E)/ TM-D710/G(A/E)/ RC-D710/ TM-D700(A/E).
- 4 Using **[TNC]**, enter the APRS mode on the TM-D710/G/ RC-D710/ TM-D700.
 - “APRS” or “TNC APRS” appears on the TH-D72(A/E)/ TM-D710/G(A/E)/ RC-D710/ TM-D700(A/E) display.
- 5 Using **[DX]**, enter the DX PacketCluster mode on the TH-D72(A/E)/ TM-D710/G(A/E)/ RC-D710/ TM-D700(A/E).
 - Every time the DX station’s information is reported to the DX PacketCluster node, the TH-D72(A/E)/ TM-D710/G(A/E)/ RC-D710/ TM-D700(A/E) stores and lists the report to the memory.
- 6 Select a desired DX station data with **[▲]/ [▼]** on the TH-D72(A/E)/ TM-D710/G(A/E)/ RC-D710/ TM-D700(A/E).
- 7 Press **[TUNE]** on the TM-D710/G(A/E)/ RC-D710 or **[MENU]** on the TH-D72(A/E) or **[MHz]** on the TM-D700(A/E) to transfer the frequency data to the TS-590SG transceiver.
 - If the transferred frequency data is available on the TS-590SG transceiver, the frequency data will be overwritten to the current operating frequency. Otherwise, the operating frequency of the TS-590SG transceiver remains unchanged.

For more detailed information on the DX PacketCluster operation of the TH-D72(A/E)/ TM-D710/G(A/E)/ RC-D710/ TM-D700(A/E), refer to their respective instruction manuals.

Note: The firmware of the TM-D700(A/E) transceiver must be version G2.0 or later to use the DX PacketCluster Tune function.

SKY COMMAND SYSTEM II

Sky Command System II allows you to remotely control the TS-590SG transceiver from a separate location.

If you have more than 2 TH-D7A/ TH-D72(A/E)/ TM-D710/G(A/E)/ TM-V71A + RC-D710/ TM-D700A transceivers, you can perform Sky Command System II operation to remotely control the HF/ 50 MHz band of your TS-590SG transceiver.

You will use one transceiver (TH-D7A, TH-D72(A/E)/ TM-D710/G(A/E), TM-V71A + RC-D710, or TM-D700A) as a remote control unit, called a “Commander”. The other VHF/ UHF transceiver (TH-D7A, TH-D72(A/E)/ TM-D710/G(A/E), TM-V71A + RC-D710, or TM-D700A) with the TS-590SG transceiver is called the “Transporter”. This TH-D7A, TH-D72(A/E)/ TM-D710/G(A/E), TM-V71A + RC-D710, or TM-D700A transceiver will function as an interface between the Commander (a remote control unit) and the HF/ 50 MHz band of the TS-590SG transceiver.

This system allows you, for example, to watch for and hunt DX while washing your car, or to operate the HF transceiver while relaxing in your car, living room, or patio, instead of actually operating inside your shack.

Note: Operation of Sky Command System II may not be permitted in certain countries. Check your local laws before operating.

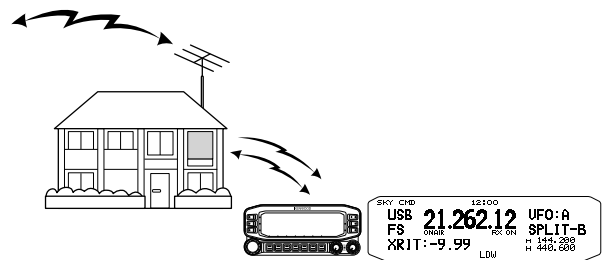

SKY COMMAND SYSTEM II DIAGRAM

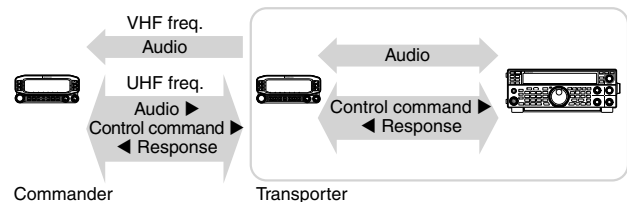

12 OPERATOR CONVENIENCES

PREPARATION

Although you can use a TH-D7A, TH-D72(A/E)/ TM-D710/G(A/E), TM-V71A + RC-D710, or TM-D700A transceiver as a “Commander” (an external remote control unit), the following procedure shows how to set up your TS-590SG and TH-D7A, TH-D72(A/E)/ TM-D710/G(A/E), TM-V71A + RC-D710, or TM-D700A transceivers as a “Transporter” at a base station and the TH-D72(A/E)/ TM-D710/G(A/E), TM-V71A + RC-D710, or TM-D700A transceiver as a “Commander”.

STARTING SKY COMMAND SYSTEM II OPERATION

After you have completed setting up the following, you can start Sky Command System II operation. Without programming these parameters, you cannot use Sky Command System II.

TS-590SG + TH-D7A/ TH-D72(A/E)/ TM-D700A/ TM-D710/G(A/E)/ TM-V71A + RC-D710 (Transporter) Setup:

- 1 Configure the TH-D7A, TH-D72(A/E)/ TM-D710/ G(A/E), TM-V71A + RC-D710, or TM-D700A as a “Transporter” and connect all the necessary cables to the TS-590SG transceiver.
- 2 Select a frequency (HF/ 50 MHz band) on the TS-590SG transceiver.
- 3 On the TS-590SG, press **[MENU]**, then turn **MULTI/CH** control to select Menu No. 67.
- 4 Press **[M.IN]/ [SCAN (SG.SEL)]** to select the desired communication speed.
- 5 Select the same communication parameters to match the TH-D7A, TH-D72(A/E)/ TM-D710/ G(A/E), TM-V71A + RC-D710, or TM-D700A transceiver.
- 6 Press **[MENU]** to exit Menu mode.
- 7 Configure and start the Transporter mode on the TH-D7A, TH-D72(A/E)/ TM-D710/G(A/E), TM-V71A + RC-D710, or TM-D700A transceiver.
 - Refer to the respective instruction manuals of the TH-D7A, TH-D72(A/E)/ TM-D710/G(A/E), TM-V71A + RC-D710, or TM-D700A for information on how to connect, configure, and operate the transceivers for Sky Command System II.

POWER ON MESSAGE

Each time you switch the transceiver ON, “KENWOOD” (default) appears on the sub display for approximately 2 seconds. You can program your favorite message in place of the default message. You can enter a message using up to 8 characters.

- 1 Press **[MENU]**, then press **[Q-M.IN]/ [Q-MR]** or turn the **MULTI/CH** control to access Menu No 01.
- 2 Press **[M.IN]/ [SCAN (SG.SEL)]** to begin editing the message.
- 3 Move the cursor to the left or right by pressing **[Q-M.IN]** or **[Q-MR]**.



- 4 Press **[M.IN]/ [SCAN (SG.SEL)]** or turn the **MULTI/CH** control to select your desired character.
 - You can delete the selected character by pressing **[CL]**.
- 5 Repeat steps 3 and 4 to enter the remaining characters.
- 6 Press **[MENU]** to set the entry and exit character entry mode.
 - Press **[CLR]** at any time to cancel character entry mode and exit the Menu mode.

Available alphanumeric characters:

A B C D E F G H I J K L M N O P Q(q) R S T U V W X
Y Z (space) * + - / 0 1 2 3 4 5 6 7 8 9

13 CONNECTING PERIPHERAL EQUIPMENT

TERMINAL DESCRIPTIONS

COM CONNECTOR

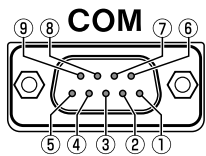

Pin No.	Pin Name	Function	I/O
1	NC	No connection	—
2	RXD	Transmit data	O
3	TXD	Receive data	I
4	NC	No connection	—
5	GND	Ground	—
6	NC	No connection	—
7	RTS	Receive enable	I
8	CTS	Transmit enable	O
9	NC	No connection	—

ACC2 CONNECTOR



Pin No.	Pin Name	Function	I/O
1	NC	No connection	—
2	RTTY	RTTY key input	I
3	ANO	Audio output from the transceiver <ul style="list-style-type: none"> Connect to the audio input of the TNC, MCP, or PC (or PC interface connection). Audio output level is independent from the AF control setting. Audio output level can be changed by adjusting the value in Menu No. 74. Set the value to a moderate audio output level. The default value of 4 is approximately 0.5 V_{p-p}, which is a standard modulating signal. The settings of 0 ~ 9 vary from approximately 0 V_{p-p} to 1.2 V_{p-p}. Impedance: Approx. 10 kΩ. 	O
4	GND	Ground	—
5	PSQ	Transceiver squelch control <ul style="list-style-type: none"> Connect to the squelch input of the TNC, MCP, or PC connection interface. Squelch open: Low impedance Squelch closed: High impedance 	O
6	NC	No connection	—
7	NC	No connection	—
8	GND	Ground	—
9	PKS	PTT input for data communication <ul style="list-style-type: none"> Connect to the PTT output of the TNC, MCP, or PC connection interface. Microphone audio input mutes when transmitting. 	I
10	NC	No connection	—
11	ANI	Audio input for data communication <ul style="list-style-type: none"> Connect to the audio output of the TNC, MCP, or PC (or PC interface connection). Audio input level is independent from the microphone gain (set with the [MIC] key). Audio input level can be changed by adjusting the value in Menu No. 73. The default value of 4 is approximately 10 mVrms, which is a standard modulating signal. The settings of 0 ~ 9 vary from approximately no modulation to approximately 1 mVrms. Impedance: Approx. 10 kΩ. 	I
12	GND	Ground	—
13	SS	PTT input (same as the front panel MIC connector) <ul style="list-style-type: none"> During transmission, the audio input of ACC2 connector terminal 11 (ANI) and the USB terminal are muted. 	I

13 CONNECTING PERIPHERAL EQUIPMENT

REMOTE CONNECTOR

REMOTE

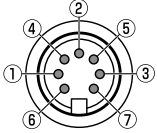

Pin No.	Pin Name	Function	I/O
1	SPO	Speaker output	O
2	COM	Common terminal	I/O
3	SS	Standby; when grounded, the transceiver enters TX mode. • During transmission, the audio input of ACC2 connector terminal 11 (ANI) and the USB terminal are muted.	I
4	MKE	When connected with the common terminal, the amplifier enters TX mode.	I/O
5	BRK	When connected with the common terminal, the amplifier enters RX mode.	I/O
6	ALC	ALC input from the amplifier (approx. -7 V).	I
7	RL	Approx. +12 V DC is output when in TX mode (10 mA max.).	O

EXT.AT CONNECTOR (for AT-300)

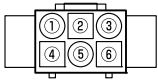

AT

Pin No.	Pin Name	Function	I/O
1	GND	Ground	—
2	TT	AT-300 control input/ output	I/O
3	GND	Ground	—
4	NC	No connection	—
5	TS	AT-300 control input/ output	I/O
6	14S	Power supply for EXT.AT Switched 13.8 V (4 A max.).	O

MIC CONNECTOR

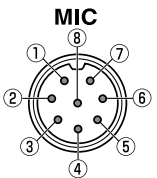

Pin No.	Pin Name	Function	I/O
1	MIC	MIC signal input	I
2	SS	MIC standby (PTT) control	I
3	MD	MIC Down control	I
4	MU	MIC UP control	I
5	8A	Switched 8 V (10 mA max.)	O
6	NC	No connection	—
7	MSG	MIC GND	—
8	MCG	GND	—

Note:

- ◆ The terminal pin numbers are arranged as seen on the front and rear panel.
- ◆ Do not use a cable exceeding 3 m (9.8 feet) with the following connectors:
 PHONES jack MIC connector COM connector EXT. SP jack ACC 2 connector REMOTE connector
 KEY jack PADDLE jack DRV connector USB connector

CONNECTING TO DATA COMMUNICATION EQUIPMENT

CONNECTING TO A COMPUTER

When performing data communications using RTTY (AFSK), PSK31, SSTV, JT65, etc., with your transceiver set to DATA mode (SSB-DATA, FM-DATA, AM-DATA), and the sound function of your computer being used for data communication software, perform the connections as below.

When using the USB audio function: connect to the computer USB port. When using DATA VOX or PC control commands to switch between transmission and reception ("TX1;" to start transmission and "RX" to end transmission), it is possible to operate data communications by using only a USB cable connection. When connecting to a computer using a USB cable, download the virtual COM port driver.

http://www.kenwood.com/i/products/info/amateur/software_download.html

When using an **ACC2** connector: connect the computer audio output line to pin 11 (ANI) of the **ACC2** connector, and connect the computer audio input line to pin 3 (ANO) of the **ACC2** connector. To switch between transmission and reception, use pin 9 (PKS) of the **ACC2** connector, DATA VOX, or the PC control command ("TX1;" to start transmission and "RX" to end transmission). <Refer to page 31 for the DATA VOX function.>

When using the PC Control Command, connect the transceiver to the computer using an RS-232C straight cable or a USB cable (A-B).

Through Menu No. 70, you can select to use the microphone or the data communication input signal from the **ACC2** connector or USB connector as the input signal that will be transmitted by operating the front panel SEND key, microphone PTT (SS), pin 13 (SS) of the ACC2 connector, or pin 3 (SS) of the REMOTE connector.

Note:

- ◆ USB cables are not provided as accessories. Purchase commercially available cables.
- ◆ Delays may occur when using USB audio and, depending on the load and performance of the computer, breaks may occur in the audio. We recommend using USB audio in situations where time lag is not an issue, such as data communications or when recording audio onto a computer.
- ◆ For information about setting up the data communication software, refer to the software's help files and documentation.
- ◆ When connecting this device to a computer, be sure to first switch off the power to this device before connecting it to the computer.

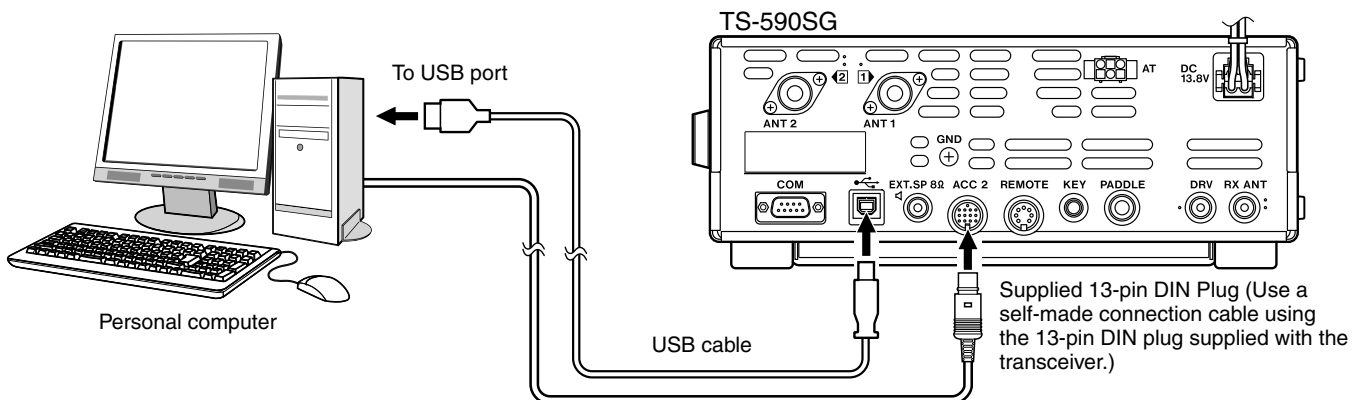

13 CONNECTING PERIPHERAL EQUIPMENT

CONNECTING TO A TNC

When the transceiver is set to DATA mode and you are operating packet communications using an external TNC (Terminal Node Controller), perform the connections as below.

Use the **ACC2** connector to connect with an external TNC. Connect the external TNC modulation output line to pin 11 (ANI) of the **ACC2** connector, demodulation input line to pin 3 (ANO) of the **ACC2** connector, and transmit control (PTT) line to pin 13 (PKS) of the **ACC2** connector.

Note:

- ◆ Do not share a single power source between the TNC and the transceiver.
- ◆ Keep as much space as possible between the transceiver and computer, and between the TNC, to prevent the transceiver from picking up noise.

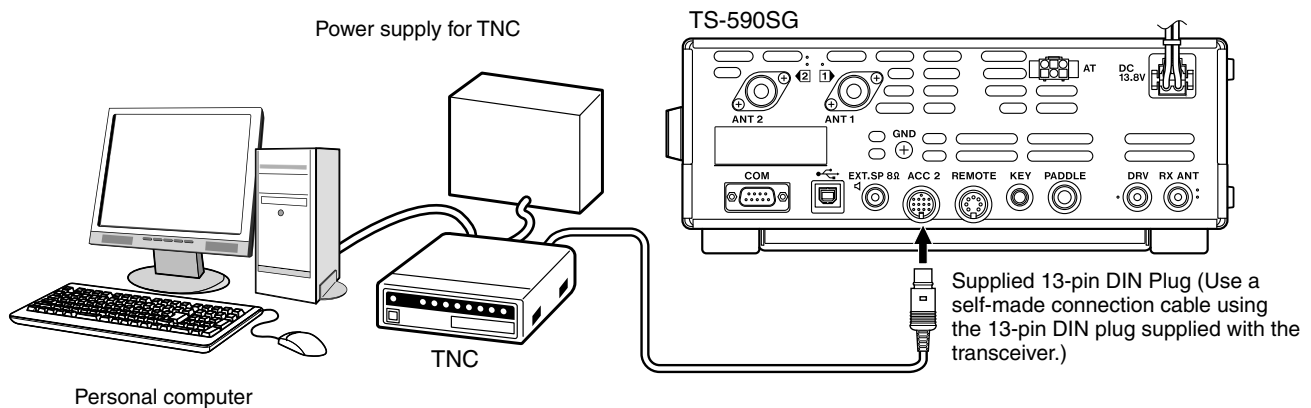

CONNECTING TO RTTY EQUIPMENT (FSK)

When the transceiver is set to FSK mode and you are operating RTTY (FSK) using an MCP (Multi Communication Processor) or RTTY equipment, perform the connections as below.

Use the **ACC2** connector to connect to the RTTY equipment. Connect the RTTY equipment keying output line to pin 2 (RTTY) of the **ACC2** connector and demodulation input line to pin 3 (ANO) of the **ACC2** connector. Additionally, connect the transmit control (PTT) line to pin 13 (SS) of the **ACC2** connector.

Note:

- ◆ Do not share a single power source between the MCP/RTTY unit equipment and the transceiver.
- ◆ Keep as much space as possible between the transceiver and computer, and between the RTTY equipment, to prevent the transceiver from picking up noise.

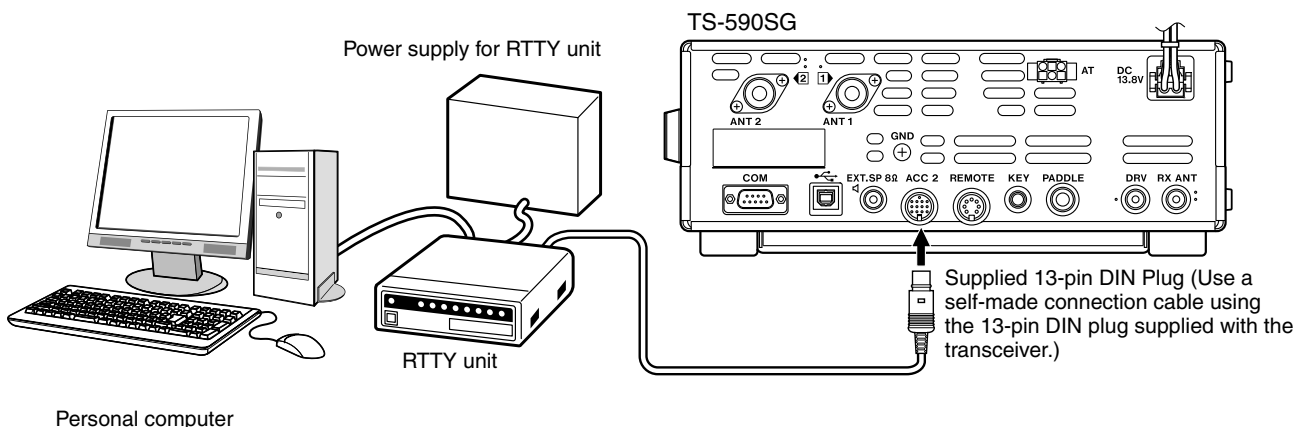

CONNECTION TO THE LINEAR AMPLIFIER

You can connect a linear amplifier to the **REMOTE** connector.

Prior to activating the linear amplifier, ensure that you have configured the linear amplifier controls {page 55}. The response time from when the transceiver changes from receive to transmit and when transmission begins, is 10 ms. In operation other than CW Full Break-in, changing the menu configuration extends the response time to 25 ms (45 ms for SSB, FM and AM modes).

Note: TL-922 has been discontinued and is no longer available.

CONNECTION TO THE TL-922

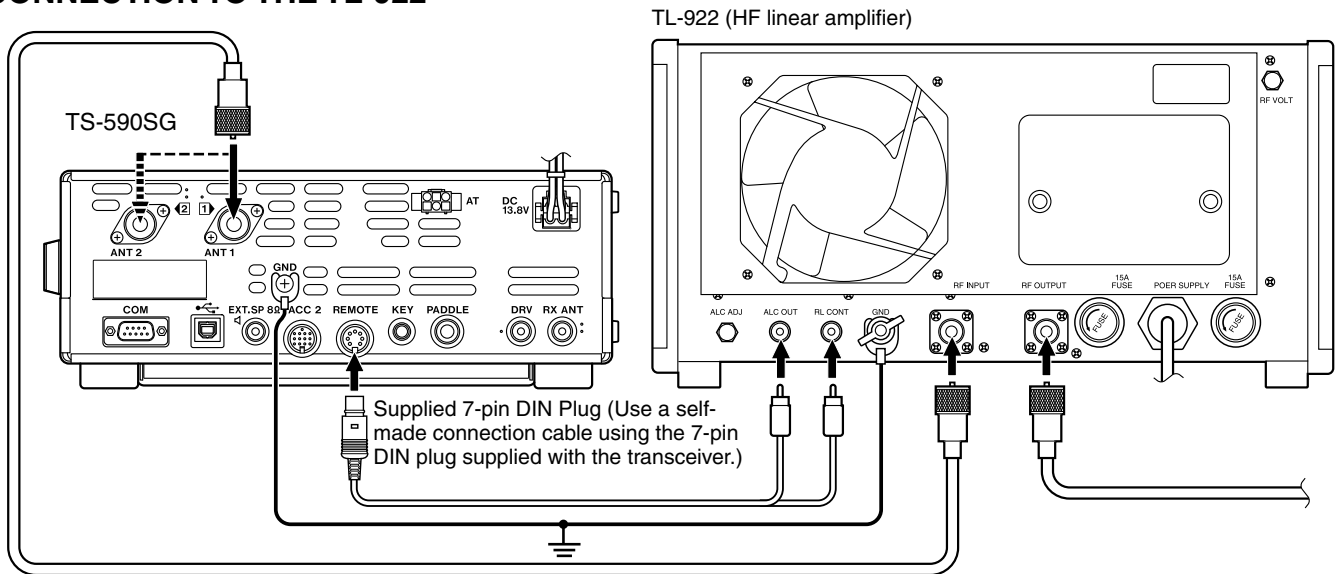

CONTROL RELAY

Allocate pin number 2 (COM) in the REMOTE connector to connect to the GND of the TL-922, and pin number 4 (MKE) to the RL CONT of the TL-922. Additionally, connect pin number 6 (ALC) to the ALC OUT of the TL-922. Configure Menu No. 59 (HF) to "3".

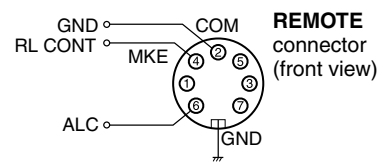

CONNECTING A TYPICAL LINEAR AMPLIFIER

To connect a commercially available linear amplifier to the transceiver, follow the instructions given in the illustration below.

Note:

- ◆ Use a linear amplifier that has an ALC output level in the range of -7 V to -10 V.
- ◆ Refer to the instruction manual supplied with the linear amplifier for connection to the linear amplifier.

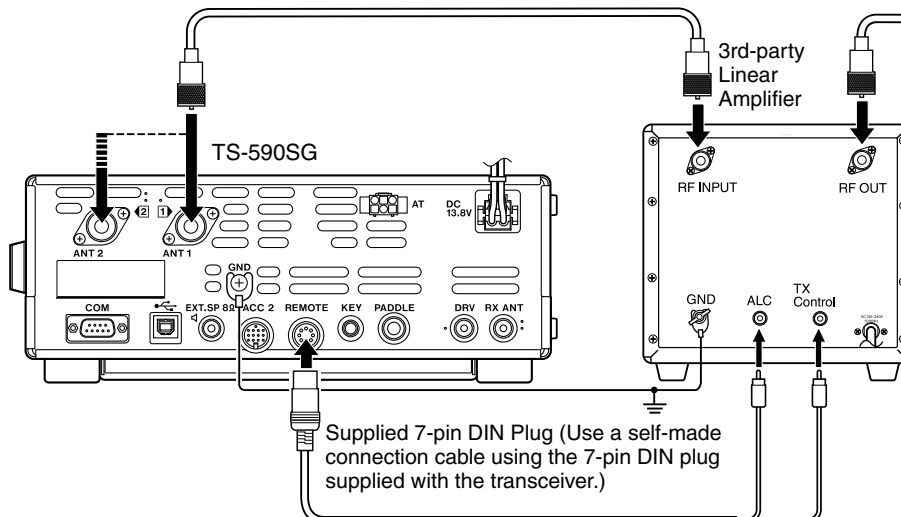

13 CONNECTING PERIPHERAL EQUIPMENT

TX/RX CONTROL

To connect a linear amplifier, configure to enable the control signal state in Menu No. 59 (HF) and Menu No. 60 (50 MHz), and make the appropriate connections between the TX/RL control terminals of the TS-590SG and the linear amplifier.

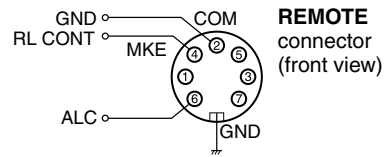

ANTENNA TUNER

Use the **ANT 1** and **AT** connectors to connect an AT-300 external antenna tuner. If you connect the external antenna tuner to the **ANT 2** connector, it will not function.

Note:

- ◆ The AT-300 cannot be used for 50 MHz operation.
- ◆ The AT-300 has been discontinued and is no longer available.

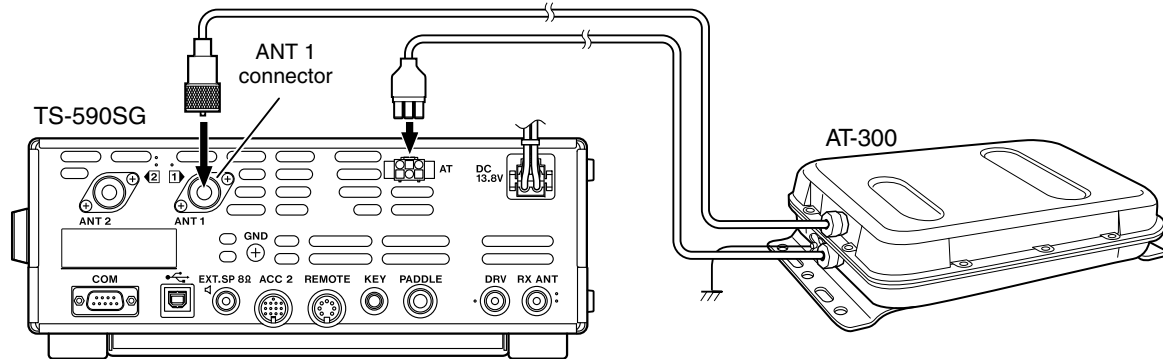

COMPATIBLE TRANSCEIVER

When transferring data to or from another TS-990S, TS-590SG, TS-590S, TS-480HX/SAT, TS-2000/X, TS-570S/D, or TS-870S, directly connect the 2 transceivers using the **COM** connectors.

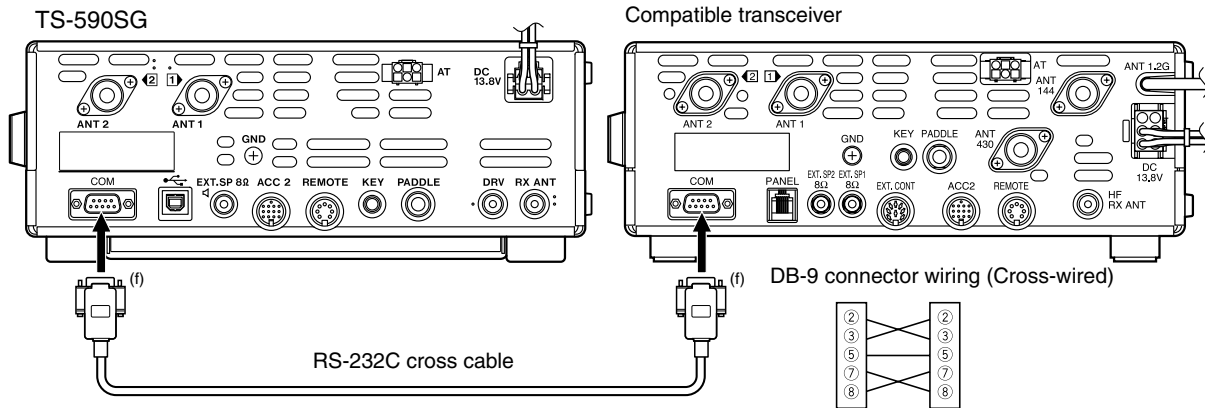

DX PACKETCLUSTER TUNE

If you have a TH-D72(A/E)/ TM-D710/G(A/E)/ RC-D710/ TM-D700(A/E), you can connect the TH-D72(A/E)/ TM-D710/G(A/E)/ RC-D710/ RC-D710/ TM-D700(A/E) to the TS-590SG transceiver to use the DX PacketCluster Tune function. Connect the 2 transceivers with a cross-wired RS-232C cable as shown below. (For connecting to the TH-D72(A/E), refer to the TH-D72(A/E) instruction manual.)

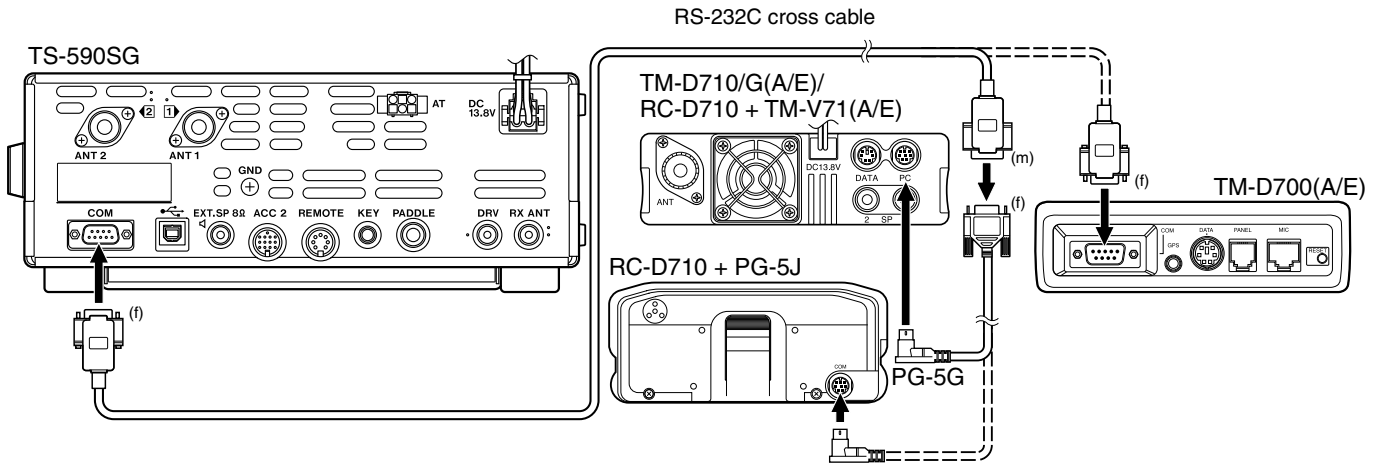

CROSSBAND REPEATER

If you have a KENWOOD FM transceiver (K type) with a 6 pin mini DIN connector, you can connect the FM transceiver to the TS-590SG transceiver to use the Crossband repeater function. Connect the 2 transceivers with a DIN (13-pin)/ mini DIN cable (6-pin) as shown below.

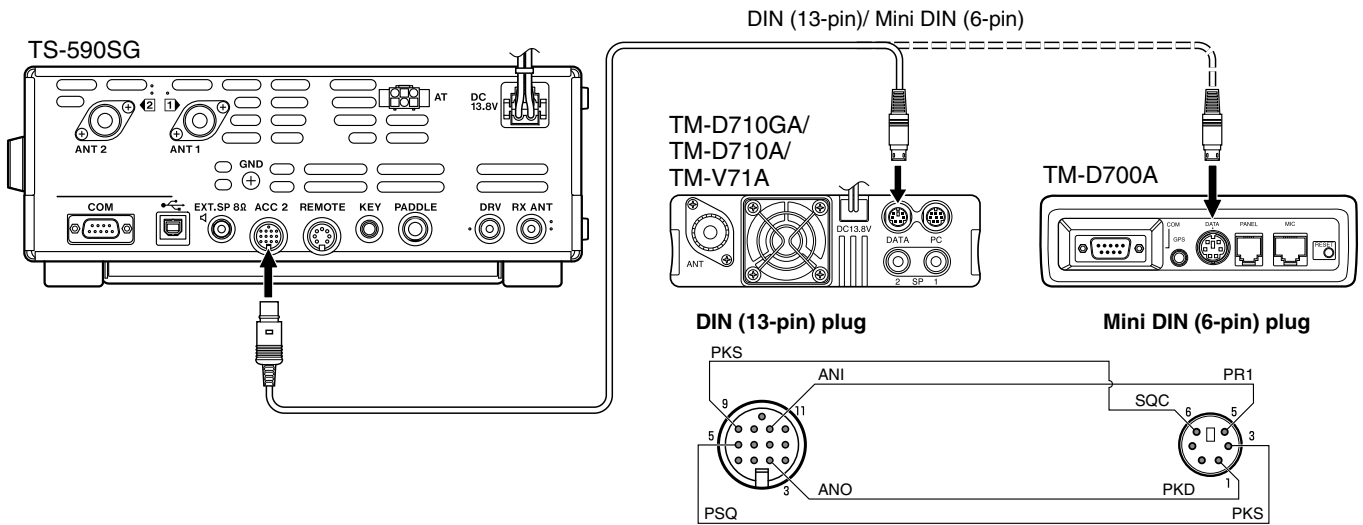

After connecting the 2 transceivers with the cable, access Menu Nos. 80 (PKS polarity) and 81 (Busy lockout) on the TS-590SG transceiver and select "on". You will further need to adjust the audio input/ output level of the TS-590SG transceiver using Menu Nos. 73 and 74.

14 INSTALLING OPTIONS

You will require a #1 Philips screwdriver to install the VGS-1 or SO-3 TCXO. You will also need a soldering iron (approx. 30 watts) to install the SO-3 TCXO.



Switch OFF the transceiver power and unplug the DC power cable before performing any installations.

REMOVING THE BOTTOM CASE

When installing the optional VGS-1 or SO-3 TCXO, remove the bottom case of the transceiver:

- 1 Remove the 10 screws.
- 2 Lift off the bottom case.

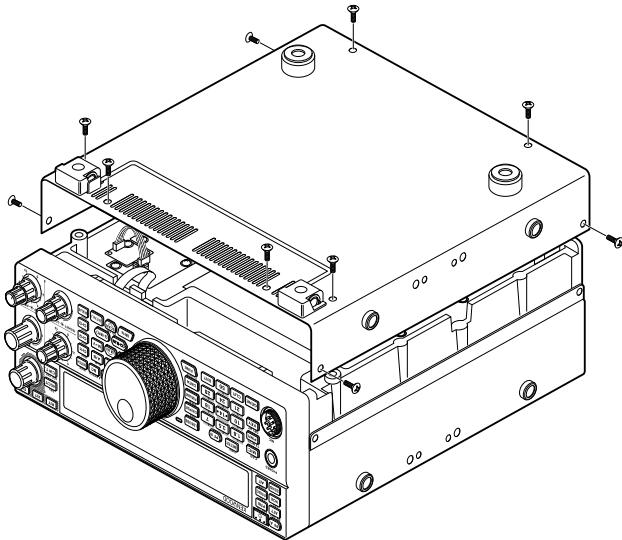

VGS-1 VOICE GUIDE & STORAGE UNIT

- 1 Remove the shield cover (4 screws).

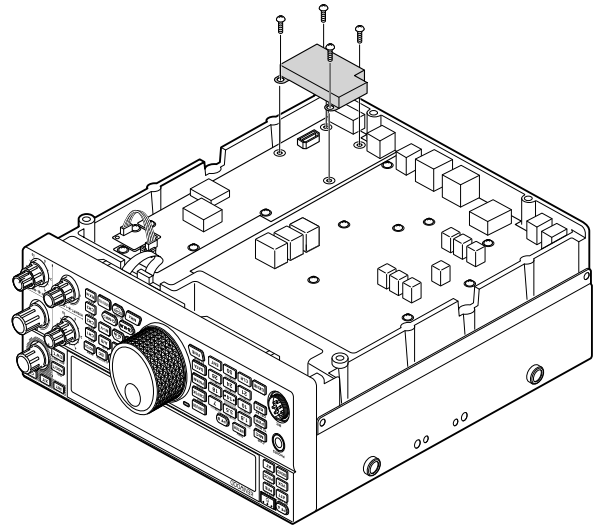

- 2 There are 5 rubber cushions in the VGS-1 package. Use the 2 rubber cushions shown below (20 x 30 x 2 mm and 21 x 21 x 2.5 mm) and attach them to the VGS-1.
 - The remaining cushions are not used.

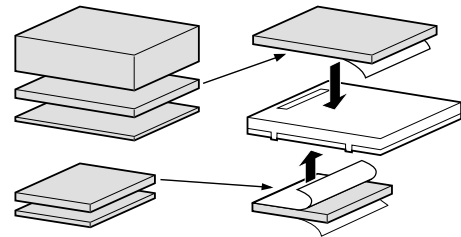

- 3 Plug the VGS-1 into the VGS-1 connector of the PC board, pressing down on the top of the VGS-1 until secure.

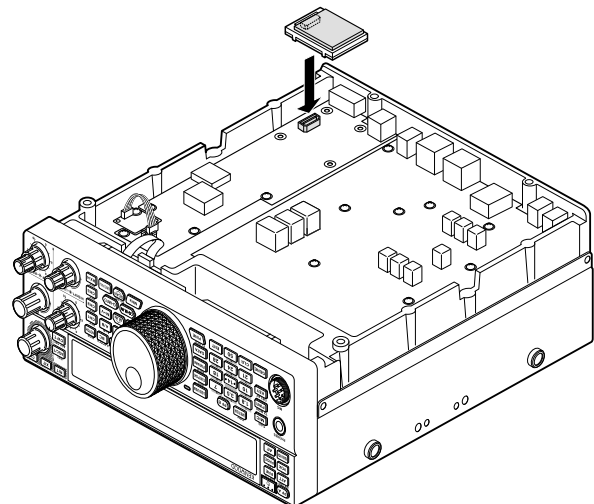

- 4 Replace the shield cover and tighten the 4 screws.
- 5 Replace the bottom case (10 screws).

Note: After installation, you can adjust the VGS-1 playback and voice guide volume by selecting Menu Nos. 05 and 06.

SO-3 TCXO

The SO-3 option improves the transceiver frequency stability to ± 0.5 ppm.

- 1 Remove the CN503 connector and TCXO PCB screw, as shown below.

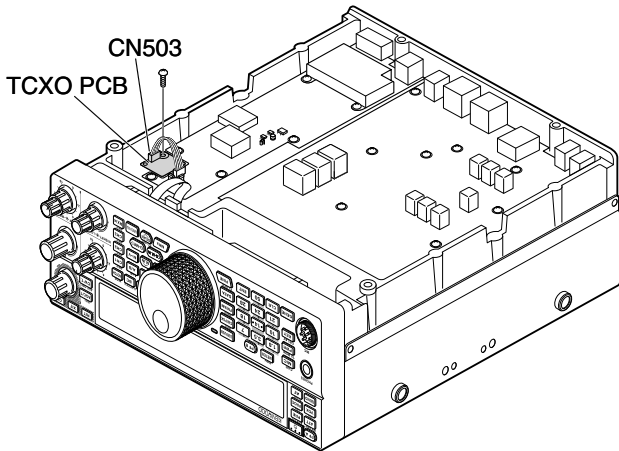

- 2 Remove the TCXO PCB.
- 3 Insert the SO-3 TCXO.
 - Align the SO-3 TCXO adjustment hole with the "O" on the TCXO PCB.

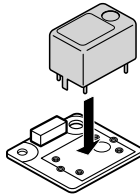

- 4 Solder all pins on the reverse side of the PCB.
- 5 Re-insert the TCXO PCB in the transceiver.
- 6 Connect the CN503 and tighten the screw.
- 7 Move the C903 and C904 jumper as shown below.

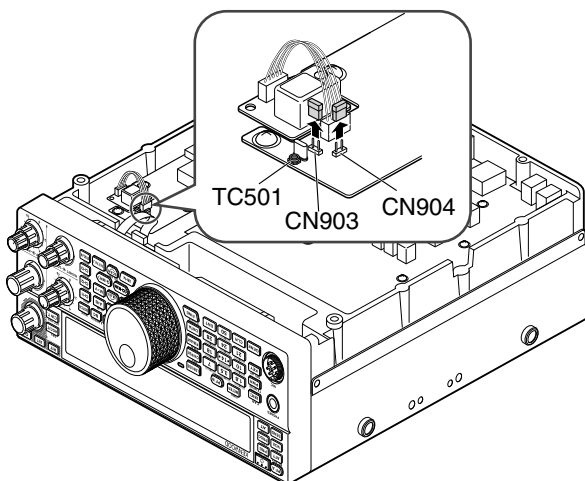

Note:

- ◆ To avoid misplacing the jumper, keep it attached to 1 pin of C903 or C904.
- ◆ When removing the SO-3 TCXO, replace the jumper to its original position.

- 8 Replace the bottom case (10 screws).

REFERENCE FREQUENCY CALIBRATION

Note: The transceiver is adjusted at the factory prior to shipping. Do not perform this adjustment unless it is necessary.

- 1 Set the following on the transceiver:
 - Mode: CW
 - **AF** control: Center
 - Menu No. 40 (CW RX pitch): 800 Hz
 - **SHIFT** control: 800 Hz
 - RIT function: OFF
 - Break-in function (VOX): OFF
- 2 Remove the bottom case (10 screws) from the transceiver.
- 3 Tune in a standard frequency station such as WWV or WWVH at, for example, 10.000.00 MHz or 15.000.00 MHz.
 - Adjust the **Tuning** control so that the display reads the exact frequency of the station.
 - You should hear a beat tone of approximately 800 Hz.
 - For 800 Hz:
 $f_{af} = (f_{display}/15.600 \times \Delta f_{reference}) + 800 \text{ Hz}$
 where $\Delta f_{reference}$ is the shift from the 15.6 MHz reference frequency.
- 4 Close your CW key. You will hear a transmit sidetone of approximately 800 Hz.
 - This sidetone produces a double beat tone when it combines with the received signal.
 - Adjust the **AF** control to hear the double beat clearly.
 - For 800 Hz:
 $f_{sidetone} = 800 \text{ Hz} \pm 50 \text{ ppm} (= 800 \pm 0.04 \text{ Hz})$
 where $\Delta f_{reference}$ is the shift from the 15.6 MHz reference frequency.
- 5 **TS-590SG transceiver without SO-3:**

Adjust the trimmer (TC501) to minimize the frequency difference between the received 800 Hz tone and the 800 Hz sidetone.

TS-590SG transceiver with SO-3:

Adjust the trimmer inside the SO-3 using the supplied plastic adjustment tool. Minimize the frequency difference between the received 800 Hz tone and the 800 Hz sidetone.

14 INSTALLING OPTIONS

MB-430 MOBILE BRACKET

ATTENTION: When installing the MB-430, use the SEMS Screws provided with the TS-590SG.

When installing the MB-430, attach the supplied plastic spacers to the transceiver in advance. This is necessary to protect the TS-590SG transceiver from scratches.

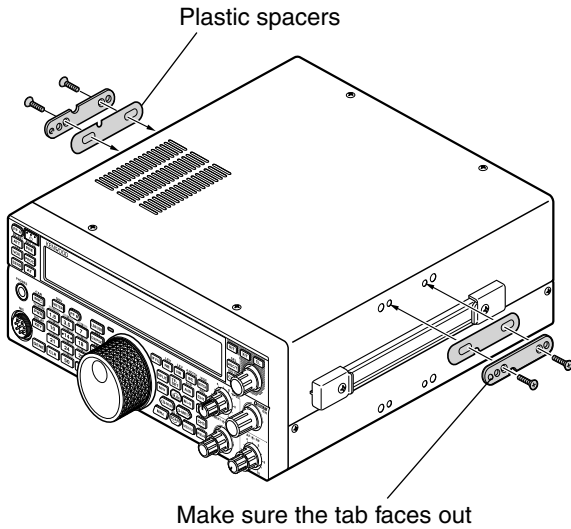

Once the bracket is installed onto the vehicle, prepare the transceiver by loosely screwing in the rear screws. Hook those screws onto the rear guide rail of the mounting bracket then adjust the transceiver to your desired angle before tightening the screws. Insert and tighten the front screws to secure the transceiver in place.

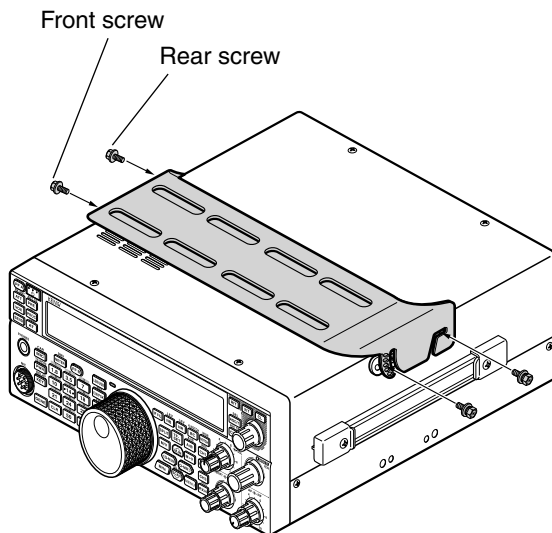

To remove the transceiver from the bracket, first remove the front screws, then loosen the rear screws slightly and pull the transceiver forward to unlatch it from the bracket.



Do not install the transceiver so that it is vertically on its side.

PRECAUTIONS

- When operating mobile, do not attempt to configure the transceiver while driving; it is too dangerous.
- Use of the transceiver while you are driving may be against traffic laws. Please check and observe the vehicle regulations in your area.

15 TROUBLESHOOTING

GENERAL INFORMATION

Your transceiver has been factory aligned and tested to specification before shipment. Under normal circumstances, the transceiver will operate in accordance with these operating instructions. All adjustable trimmers, coils, and resistors in the transceiver are preset at the factory. They should only be readjusted by a qualified technician who is familiar with this transceiver and has the necessary test equipment. Attempting service or alignment without factory authorization may void the transceiver warranty.

When operated properly, the transceiver will provide years of service and enjoyment without requiring further realignment. The information in this section gives some general service procedures requiring little or no test equipment.

SERVICE

If it is ever necessary to return the equipment to your dealer or service center for repairs, pack the transceiver in its original box and packing material. Include a full description of the problems experienced. Include both your telephone number and fax number (if available) along with your name and address in case the service technician needs to call for further information while investigating your problem. Don't return accessory items unless you feel they are directly related to the service problem. Please do not send subassemblies or printed circuit boards. Send the complete transceiver.

You may return your transceiver for service to the authorized **KENWOOD** dealer from whom you purchased it or any authorized **KENWOOD** service center. A copy of the service report will be returned with the transceiver.

Tag all returned items with your name and call sign for identification. Please mention the model and serial number of the transceiver in any communication regarding the problem.

SERVICE NOTE

If you desire to correspond on a technical or operational problem, please make your note short, complete, and to the point. Help us help you by providing the following:

- Model and serial number of equipment
- Question or problem you are having
- Other equipment in your station pertaining to the problem
- Meter readings
- Other related information (Menu setup, mode, frequency, key sequence to induce malfunction, etc.)



CAUTION

Do not pack the equipment in crushed newspapers for shipment. Extensive damage may result during rough handling or shipping.

Note:

- ◆ Record the date of purchase, serial number, and dealer from whom the transceiver was purchased.
- ◆ For your own information, retain a written record of any maintenance performed on the transceiver.
- ◆ When claiming warranty service, please include a photocopy of the bill of sale or other proof-of-purchase showing the date of sale.

CLEANING

The keys, controls, and case of the transceiver are likely to become soiled after extended use. Remove the controls from the transceiver and clean them with a neutral detergent and warm water. To clean the case, use a neutral detergent (no strong chemicals) and a damp cloth.

FIRMWARE UPDATING

ABOUT FIRMWARE UPDATING

You can update the transceiver firmware anytime an update becomes available. Updating the firmware may improve the functionality or add new functions. The latest firmware can be downloaded from the **KENWOOD** website. For the Firmware updating procedure, refer to "Firmware update information" on the website.

http://www.kenwood.com/i/products/info/amateur/software_download.html

VERIFYING THE FIRMWARE VERSION

Before you begin updating the firmware, verify your current transceiver firmware version by accessing Menu No. 00.

15 TROUBLESHOOTING

TROUBLESHOOTING

The problems described in this table are commonly encountered operational malfunctions. These types of difficulties are usually caused by improper hook-up, accidental incorrect control settings, or operator error due to incomplete programming. These problems are usually not caused by circuit failure. Please review this table and the appropriate section(s) of this instruction manual before assuming your transceiver is defective.

Note: Placing a powered portable transceiver near this transceiver may cause noise in the transceiver.

Problem	Probable Cause	Corrective Action	Page
The transceiver will not power up after connecting a 13.8 V DC power supply and pressing [⏻]. Nothing appears on the display and no receiver noise is heard.	1 DC power supply is OFF.	1 Switch the DC power supply ON.	10
	2 Faulty power cable.	2 Inspect the power cable. Confirm that the polarities are correct (Red: positive (+); Black; negative (-)).	1
	3 The power cable is not connected securely.	3 Confirm the connections to the DC power supply are secure.	1
	4 The power cable fuse is open.	4 Look for the cause of the blown fuse. After inspecting and correcting any problems, install a new fuse of the specified rating.	2
After switching the power ON, the transceiver does not function normally. For example, no digits or incorrect digits appear on the display.	1 The input voltage is outside 13.8 V DC $\pm 15\%$ (11.7 ~ 15.8 V DC)	1 Correct the input voltage or use a 12 ~ 16 V battery.	1
	2 The microprocessor has malfunctioned.	2 Review "MICROPROCESSOR RESET". After understanding what data will be lost, do a VFO Reset. If the problem remains, do a Full Reset.	83
After switching the transceiver ON, the transceiver refuses to transmit.	The current rating of the DC power supply is too low.	Use a DC power supply that has a 20.5 A or higher current rating	1
The transceiver does not respond correctly after pressing key combinations or turning controls per instructions in this manual.	1 Procedures are not being followed precisely.	1 Review "WRITING CONVENTIONS FOLLOWED".	ii
	2 The Frequency Lock function is ON.	2 Press and hold [FINE (F.LOCK)] to switch the function OFF. The "🔒" icon disappears.	56
	3 The microprocessor and its memory need to be reset.	3 Review "MICROPROCESSOR RESET". After understanding what data will be lost, do a Partial Reset. If the problem remains, do a Full Reset.	83
The frequency cannot be changed.	The Frequency Lock function is ON.	Press and hold [FINE (F.LOCK)] to switch the function OFF. The "🔒" icon disappears.	56
SSB audio quality is very poor; the high or low audio frequencies are absent.	1 The wrong operation mode is selected for the receiver.	1 Select USB or LSB for the mode.	11
	2 The IF filter is incorrectly set.	2 Turn the HI/SHIFT or LO/WIDTH control to adjust the DSP filter width.	40
	3 Noise Reduction 1 or 2 is ON.	3 Press [NR (LEV)] until the NR function turns OFF.	41
	4 Beat Cancel 1 or 2 is ON.	4 Press [BC (A.NOTCH)] until the BC function turns OFF.	41
No signals are received or receive sensitivity seems poor.	1 The SQL control is fully clockwise.	1 Turn the SQL control counterclockwise.	12
	2 The Attenuator is ON.	2 Press [ATT (RX ANT)] to switch the Attenuator is OFF.	42
	3 MIC [PTT] is pressed.	3 Release MIC [PTT].	13
	4 The IF filter bandwidth was incorrectly set.	4 Review "DSP FILTERS", and set the controls accordingly.	40
	5 The wrong antenna connector (ANT 1 or ANT 2) was selected.	5 Press and hold [PRE (ANT 1/2)] to select the other antenna connector.	52
	6 The pre-amplifier is OFF.	6 Press [PRE (ANT 1/2)] to switch the function ON.	42
	7 An internal DSP error occurs.	7 Restart the transceiver by turning the power OFF and then back ON. If the problem persists, consult KENWOOD authorized Service Center.	—

Problem	Probable Cause	Corrective Action	Page
No signals are received or receive sensitivity seems poor; S-meter is reading full scale.	The RF gain was set too low.	Turn the RF control clockwise to increase the RF gain.	10
Received signals are completely unintelligible	The wrong modulation was selected.	Select the correct modulation mode.	11
Memory Scan will not start scanning.	1 The SQL control was not set correctly.	1 Adjust the SQL control to just eliminate background noise.	12
	2 Less than 2 memory channels were unlocked.	2 Unlock at least 2 memory channels.	46
	3 Less than 2 memory channels were programmed.	3 Store data in at least 2 memory channels.	43
Memory Scan will not scan one of the stored channels; the desired channel is not locked out.	With Group Scan selected, the channel you want to scan is in a different group.	Select the Memory Group that contains the memory channel you want to scan.	51
Program Scan will not start scanning.	The start and end frequencies are identical	Store different start and end frequencies.	48
AT does not finish successfully.	The impedance of the coaxial cable and antenna was not matched. Tuning does not successfully finish depending on conditions, although the SWR meter indicates smaller than 3:1.	Adjust the antenna system to lower the SWR.	52
The internal tuner is bypassed immediately after tuning is started.	The SWR of the antenna system is too high.	Adjust the antenna system to lower the SWR	52
You cannot transmit even though you press MIC [PTT] , or transmissions result in no contacts.	1 The microphone plug was not inserted completely into the MIC connector.	1 Turn OFF the power, ensure the MIC connector has no foreign objects in it, then plug in the connector firmly.	2
	2 The Transmit Inhibit function is ON.	2 Change Menu No. 66 to OFF.	33
	3 CW or FSK was selected instead of a voice mode.	3 Select the correct voice mode.	11
	4 The DSP TX filter bandwidth was improperly selected.	4 Adjust the settings in Menu Nos. 31, 32.	33
	5 The wrong antenna connector (ANT 1 or ANT 2) was selected.	5 Press and hold [PRE (ANT 1/2)] to select the other antenna connector.	52
Attempting to transmit results in the "HELLO" message appearing and the reception mode being restored.	1 The antenna is not connected correctly.	1 Check the antenna connection. Correct as necessary.	1
	2 The impedances of the antenna and transceiver are not properly matched.	2 Reduce the SWR of the antenna system.	52
	3 The input voltage is outside 13.8 V DC \pm 15% (11.7 ~ 15.8 V DC).	3 Correct the input voltage or use a 12 ~ 16 V battery.	1
	4 The current rating of the DC power supply is not enough.	4 Use a DC power supply that has a current rating of more than 20.5 A at 13.8 V DC.	1
The transceiver has low transmission power.	1 The microphone gain is set too low.	1 When in SSB or AM mode, increase the microphone gain.	13
	2 Poor antenna system connections are causing high SWR.	2 Check the antenna connections. Confirm that the antenna tuner is reporting a low SWR.	52

15 TROUBLESHOOTING

Problem	Probable Cause	Corrective Action	Page
VOX does not operate.	The VOX gain is set too low.	Increase the VOX gain.	32
HF/ 50 MHz Linear amplifier does not operate.	1 The linear amplifier control is OFF.	1 Set Menu No. 59 (HF) or 60 (50 MHz) to 1, 2, 3, 4, or 5.	55
	2 The REMOTE connector wiring is wrong or faulty.	2 Inspect the REMOTE connector wiring and correct it as necessary.	70
The transceiver's output power decreases after a short operating time.	1 The air filters for the cooling fans have been congested with dust.	1 Contact a KENWOOD authorized service center to clean the filters.	—
	2 The cooling fans cannot provide enough air flow to cool the transceiver down.	2 Relocate the transceiver so that air can easily flow through the TS-590SG to keep the unit cooled.	—
You cannot access and use repeaters.	1 Many repeaters require a subtone or 1750 Hz tone to access.	1 Review "FM REPEATER OPERATION" and select the correct frequency and type of subtone.	25
	2 Transmission and/or reception frequency is wrong.	2 You must transmit on the repeater's input frequency and receive on the repeater's output frequency. Refer to "FM REPEATER OPERATION".	25
Digital operation results in few or no connects or contacts with other stations.	1 Physical connections between the transceiver, computer, and TNC/ MCP are incorrect, or software settings in the TNC/ MCP are wrong.	1 Re-check all connections using this manual, your TNC/ MCP manual, and your computer hardware manual as references.	72
	2 Different transmission and reception frequencies are being used.	2 Confirm that the RIT and XIT functions are switched OFF. Confirm that you are not operating split frequency.	30,32
	3 The levels between the transceiver and the TNC/ MCP are incorrect.	3 Adjust TX and RX levels using Menu Nos. 73 and 74, and level controls on your TNC/ MCP.	61,72
	4 Your transmitted signal or the incoming receive signal is too weak.	4 Reorient/ relocate your antenna or increase your antenna gain.	1
	5 The TX delay time parameter in your TNC/ MCP was incorrectly set.	5 Set the TNC/ MCP TX delay time to more than 300 ms.	—
Attempts at controlling the transceiver with the computer have failed.	1 Problem with cable that connects the PC to the TS-590SG.	1 Check the cable and cable connections.	71
	2 Communication parameters set in your terminal program do not match the transceiver parameters.	2 Use the same parameters in the terminal and the transceiver. Check Menu Nos. 67 and 68.	60
"TEMP-HI" appears and "CHECK" in Morse code sounds.	A sensor in the transceiver detected high temperature.	Stop transmitting and let the transceiver cool down for a while. Contact a KENWOOD authorized service center to clean the internal air filters.	—
Transmission suddenly stops.	The voltage of the DC power supply is too high.	Adjust the DC power supply voltage to 13.8 V DC.	1
"DSP ERR x" appears (where x is a number from 0 ~ 3).	An internal DSP error occurs.	Restart the transceiver by turning the power OFF and then back ON. If the problem persists, consult KENWOOD authorized Service Center.	—
"VGS ERR" appears.	An internal error occurred in the VGS-1.	Confirm that the connector of the VGS-1 is securely connected to the transceiver, then turn the transceiver power OFF and ON. If the problem persists, contact a KENWOOD authorized service center for repairs.	76

Problem	Probable Cause	Corrective Action	Page
A message cannot be recorded/ played back or no announcement can be heard.	There is a communication error between the transceiver and the VGS-1.	Confirm that the connector of the VGS-1 is securely connected to the transceiver. Perform the Full reset. If the problem persists, contact a KENWOOD authorized service center for repairs (with the VGS-1 attached).	76,83
The transceiver output power seems to be low in SSB mode.	Most of the external RF power meters measure the average RF power. So, the meter reading is low when you operate and talk in SSB mode. The LCD meter used in the TS-590SG has relatively fast response time but it is not fast enough to measure the accurate PEP (Peak Envelope Power).	Apply a continuous single tone (1 kHz) to the microphone audio input to measure the RF output power. The PEP will be the same as this RF output level.	—
The PC and external equipment is not modulating.	The input terminal is different from the one specified (Menu No. 69) for the external equipment.	Confirm that the setting of Menu No. 69 matches the input terminal for the external equipment.	61

MICROPROCESSOR RESET

If your transceiver seems to be malfunctioning, resetting the microprocessor to its default settings may resolve the problem. There are 2 levels of resetting the microprocessor of the TS-590SG transceiver: Partial Reset and Full Reset.

INITIAL SETTINGS

For each VFO, the factory defaults for the operating frequency and mode are as follows:

- VFO A: 14.000.00 MHz/ USB
- VFO B: 14.000.00 MHz/ USB

The Memory channels and Quick Memory channels have no data stored.

VFO RESET

Perform a VFO Reset if a key or control does not function according to the instructions in this manual. The following data is NOT erased by performing a VFO Reset.

- Memory channel data
 - Menu settings
 - Antenna tuner preset data
 - ANT 1/ ANT 2 selection data
 - Frequency and mode data for the Auto Mode function
 - Various adjustment setting values
- 1 Turn the transceiver power OFF.
 - 2 Press **[A/B (A=B)]** + **[⏻]** to switch the transceiver ON.
 - A confirmation message appears on the display.
 - 3 Turn the **MULTI/CH** control and select "VFO RESET".
 - 4 Press **[A/B (A=B)]** to perform the VFO reset.

- A confirmation message appears when performing the VFO Reset. Press **[A/B (A=B)]** again to proceed. Otherwise, press any other key to cancel the VFO Reset and return to normal operation.
- The VFOs reset to the factory default values.

FULL RESET

Perform a Full Reset if you want to erase all the data in all the memory channels. In addition, this function resets all the settings that you customized, to the factory defaults (i.e.- menu settings, antenna tuner preset data, etc.).

- 1 Turn the transceiver power OFF.
- 2 Press **[A/B (A=B)]** + **[⏻]** to switch the transceiver ON.
 - A confirmation message appears on the display.
- 3 Turn the **MULTI/CH** control and select "FULL RESET".
- 4 Press **[A/B (A=B)]** to perform the Full reset.
 - A confirmation message appears when performing the Full Reset. Press **[A/B (A=B)]** again to proceed. Otherwise, press any other key to cancel the Partial Reset and return to normal operation.
 - All frequencies, modes, memory data, adjustment values, and AT preset data are set to the factory default values.

OPERATION NOTICES

The transceiver has been designed and engineered to avoid possible hardware glitches. However, you may notice the following symptoms when you operate the transceiver. These symptoms are not malfunctions.

DC POWER SUPPLY

As stated in the SPECIFICATIONS {page 80}, this transceiver requires a supplied DC voltage source of 13.8 V \pm 15%. If you find that the transceiver cannot be switched ON, or that it shuts OFF automatically, the DC voltage may be outside the specified range.

In such a case, remove the DC cable from the transceiver immediately and confirm that the supplied voltage is within the specified range.

INTERNAL COOLING FAN

The transceiver detects the temperature of the final department regardless of the transmission and reception state of the main body, in order to protect the internal circuits from high temperatures. The cooling fan speed and transmission output is controlled through the following.

- When the thermistor detects a rise in temperature in the final department, the cooling fan turns on at low speed. As the temperature rises, the speed of the cooling fan increases.
- When an abnormally high temperature is detected, the temperature protection circuit activates, reducing the transmission output to the lowest possible power.

When the temperature protection circuit activates, return the transceiver to receive mode and leave the transceiver power ON. Allow time for the cooling fan to return the internal temperature to normal.

- If you turn the transceiver power OFF, the cooling fan will not run and it will take much longer for the internal temperature to decrease.

INTERNAL BEATS

On some spots of the receiver frequencies, the S-meter moves or you cannot receive any signals. This is inevitable when you use superheterodyne receivers. You may notice the signals on the following spots of the frequency:

- 15.600.00 MHz
- 31.200.00 MHz
- 46.800.00 MHz

AGC

When you turn the AGC function OFF {page 30}, the receiving audio signals can be distorted. In this case, decrease the RF gain, turn the pre-amplifier OFF, or turn the attenuator ON. In general, the RF gain must be greatly reduced when the AGC is turned OFF.

60 m BAND OPERATION

Effective from July 3, 2003, FCC Report and Order (R&O) in ET Docket 02-98 granted US amateurs secondary access to five discrete channels in the vicinity of 5 MHz. General, Advanced, and Amateur Extra licensees may use the following five channels on a secondary basis with a maximum effective radiated power of 50 W PEP relative to a half wave dipole. Only upper sideband suppressed carrier voice transmissions may be used. The frequencies are 5330.5, 5346.5, 5366.5, 5371.5 and 5403.5 kHz. The occupied bandwidth is limited to 2.8 kHz centered on 5332, 5348, 5368, 5373, and 5405 kHz respectively. The TS-590SG transceiver stops at the 60 m band as you scroll up or down the amateur radio frequency bands. For more information, contact ARRL or search their Web site using the key word "60 meter":

<http://www.arrl.org>

16 OPTIONAL ACCESSORIES

HS-5
Delux Headphones



HS-6
Small Headphones



MC-43S
Microphone



MC-47
Multi-function Microphone



MC-60A
Desk-top Microphone



MC-90
DSP-compatible Desk-top Microphone



Microphone sensitivity is low in FM mode.

PG-20
DC cable (7 m / 23 ft)



PS-60
Regulated DC Power Supply (22.5 A)



SO-3
TCXO unit



VGS-1
Voice Guide and Storage unit



SP-23
External Speaker



KES-3S
External Speaker



MB-430
Mobile Bracket

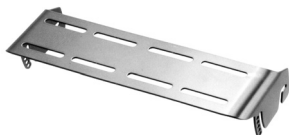

ARCP-590G/ ARHP-590G
Remote control software

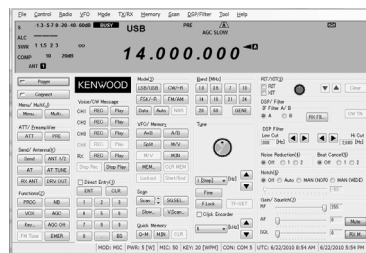

Download the free ARCP-590G/ARHP-590G software from the following URL:

http://www.kenwood.com/i/products/info/amateur/software_download.html

17 SPECIFICATIONS

General		
Mode	J3E (LSB, USB)/ A1A (CW)/ A3E (AM)/ F3E (FM)/ F1B (FSK)	
Antenna impedance	50 Ω (with built-in antenna tuner 16.7 Ω ~ 150 Ω)	
Supply Voltage	DC 13.8 V ±15%	
Grounding method	Negative ground	
Current	Transmit (max.)	20.5 A or less
	Receive (no signal)	1.5 A or less
Usable temperature range	-10 °C ~ +50 °C (+14 °F ~ +122 °F)	
Frequency stability without SO-3	-10 °C ~ 50 °C	±5 ppm
Frequency stability with SO-3	-10 °C ~ 50 °C	±0.5 ppm
Dimensions (Projections not included)	W270 × H96 × D291 mm (W10.63 x H3.78 x D11.46 in)	
Dimensions (Projections included)	W280 × H107 × D335 mm (W11.02 x H4.21 x D13.19 in)	
Weight	Approx. 7.4 kg (16.31 lbs)	

Transmitter			
Frequency range	160 m band	1.8 ~ 2.0 MHz (K type)/ 1.81 ~ 2.0 MHz (E type)	
	80 m band	3.5 ~ 4.0 MHz (K type)/ 3.5 ~ 3.8 MHz (E type)	
	60 m band	5.1675 MHz (K type) 5.25 ~ 5.45 MHz (E type: Refer to applicable Amateur Radio regulations to your country.)	
	40 m band	7.0 ~ 7.3 MHz (K type)/ 7.0 ~ 7.2 MHz (E type)	
	30 m band	10.1 ~ 10.15 MHz	
	20 m band	14.0 ~ 14.35 MHz	
	17 m band	18.068 ~ 18.168 MHz	
	15 m band	21.0 ~ 21.45 MHz	
	12 m band	24.89 ~ 24.99 MHz	
	10 m band	28.0 ~ 29.7 MHz	
	6 m band	50.0 ~ 54.0 MHz (K type) / 50.0 ~ 52.0 MHz (E type)	
Output power	SSB/ CW/ FSK/ FM	Max.	100 W
		Min.	5 W
	AM	Max.	25 W
		Min.	5 W
Maximum frequency deviation (FM)	Wide	±5 kHz or less	
	Narrow	±2.5 kHz or less	
Modulation	SSB	Balanced	
	AM	Low power	
	FM	Reactance	
Spurious emissions	160 m ~ 10 m band	-50 dB or less	
	6 m band	-60 dB or less (K type)/ -63 dB or less (E type)	
Carrier suppression (SSB)	50 dB or more		
Unwanted sideband suppression	50 dB or more		

Transmitter	
Transmit frequency response	Within -6 dB (400 ~ 2600 Hz)
XIT shift frequency range	±9.999 kHz
Microphone impedance	600 Ω

Receiver			
Circuit type		RX1 (In 160 m/ 80 m/ 40 m/ 20 m/ 15 m Amateur bands, IF band width 2.7 kHz or less (SSB, CW, FSK))	RX2 (Other)
		Double conversion superheterodyne	Triple conversion superheterodyne
Frequency range		0.13 ~ 30 MHz, 50 ~ 54 MHz VFO: Continuous 30 kHz ~ 60 MHz	
Intermediate frequency	1st IF	11.374 MHz	73.095 MHz
	2nd IF	24 kHz	10.695 MHz
	3rd IF	–	24 kHz (except FM)/ 455 kHz (FM)
Sensitivity (Typical)	SSB/ CW/ FSK (S/N 10 dB)	0.5 μV (0.13 ~ 0.522 MHz) 4 μV (0.522 ~ 1.705 MHz) 0.2 μV (1.705 ~ 24.5 MHz) 0.13 μV (24.5 ~ 30.0 MHz) 0.13 μV (50.0 ~ 54.0 MHz)	
	AM (S/N 10 dB)	6.3 μV (0.13 ~ 0.522 MHz) 31.6 μV (0.522 ~ 1.705 MHz) 2 μV (1.705 ~ 24.5 MHz) 1.3 μV (24.5 ~ 30.0 MHz) 1.3 μV (50.0 ~ 54.0 MHz)	
	FM (12 dB SINAD)	0.22 μV (28.0 ~ 30.0 MHz) 0.22 μV (50.0 ~ 54.0 MHz)	
Squelch sensitivity	SSB/ CW/ FSK/ AM	5.6 μV or less (0.13 ~ 0.522 MHz) 18.0 μV or less (0.522 ~ 1.705 MHz) 1.8 μV or less (1.705 ~ 30 MHz) 1.1 μV or less (50.0 ~ 54.0 MHz)	
	FM	0.2 μV or less (28.0 ~ 30.0 MHz) 0.2 μV or less (50.0 ~ 54.0 MHz)	
Selectivity	SSB	2.2 kHz or more (-6 dB), 4.4 kHz or less (-60 dB)	
	CW/ FSK	500 Hz or more (-6 dB), 1.2 kHz or less (-60 dB)	
	AM	6.0 kHz or more (-6 dB), 12.0 kHz or less (-50 dB)	
	FM	12.0 kHz or more (-6 dB), 25.0 kHz or less (-50 dB)	
Spurious response	Image Ratio	70 dB or more	
	IF Rejection	70 dB or more	
Notch filter attenuation	Auto	60 dB or more	
	Manual	70 dB or more	
Beat cancel attenuation (at 1 kHz)		40 dB or more	
Audio output		1.5 W (8 Ω)	
Audio output impedance (EXT.SP)		4 Ω ~ 8 Ω	
RIT shift frequency range		±9.999 kHz	

Specifications are subject to change without notice due to advancements in technology.

KENWOOD

© 2014 JVC KENWOOD Corporation

CE 0682 ⓘ